

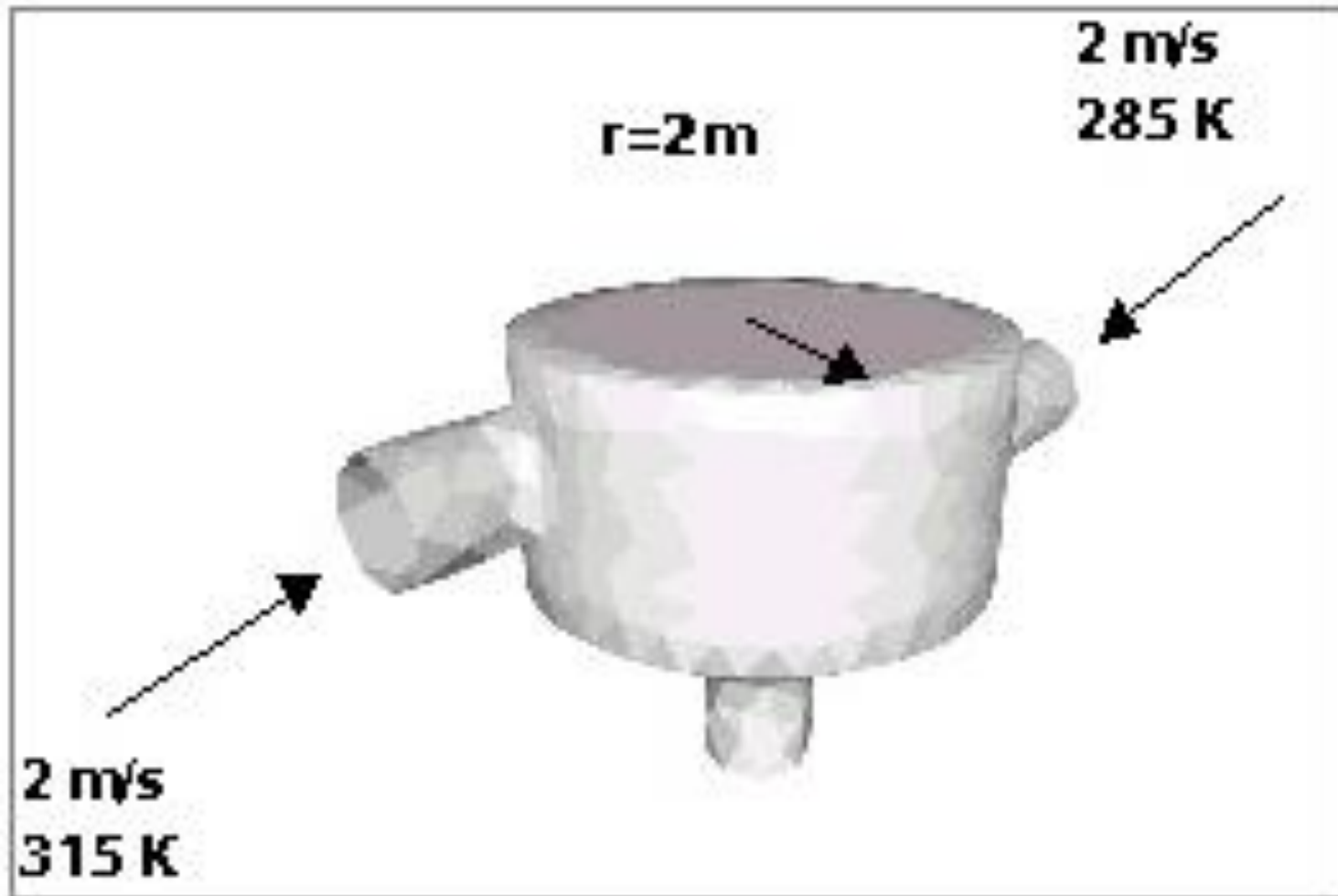

СУПЕРКОМПЬЮТЕРНЫЙ ЦЕНТР
Южно-Уральского государственного университета

Подготовка задачи в препроцессоре ANSYS CFX

Моделирование течения в статическом миксере





Far Manager

user

Интернет
Internet Explorer

Электронная почта
Outlook Express

ANSYS CFX 11.0

Проигрыватель Windows
Media

Windows Messenger

Знакомство с Windows XP

ANSLIC_ADMIN Utility

Paint

Все программы

Мои документы

Недавние документы ▶

Мои рисунки

Моя музыка

Мой компьютер

Панель управления

Выбор программ по
умолчанию

Принтеры и факсы

Справка и поддержка

Поиск

Выполнить...

Выход из системы

Завершение работы

пуск



Корзина

RL

12:59

putty060

Far Manager

ANSYS CFX-11.0 Launcher (on COMP1)

File Edit CFX Show Tools User Help

CFX-Pre 11.0 CFX-Solver 11.0 CFX-Post 11.0

Working Directory C:/CFX

Корзина





- New Simulation... Ctrl+N
- Open Simulation... Ctrl+O
- Close Ctrl+W
- Save Simulation Ctrl+S
- Save Simulation As...
- Import Mesh...
- Reload Mesh Files
- Write Solver File...
- Import CCL...
- Export CCL...
- Print... Ctrl+P
- Recent Simulation Files ▶
- Recent CCL Files ▶
- Recent Session Files ▶
- Quit Ctrl+Q





New Simulation ? X

Simulation Type

- General
- Turbomachinery
- Quick Setup**
- Library Template

OK Cancel



New Simulation [?] [X]

Simulation Type

- General
- Turbomachinery
- Quick Setup
- Library Template

OK Cancel

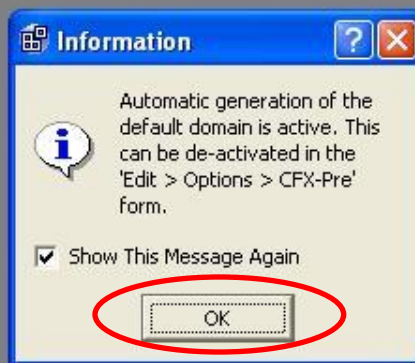



Simulation Definition

Simulation Data

Problem Type

In a single phase simulation only one fluid is present. In general the fluid is a pure substance, which is a material with specified physical properties.

Fluid Data

Select a single fluid.

Fluid

Mesh Data

Mesh File Available Volumes

< Back

Next >

Cancel

View 1 ▾

ANSYS

0 0.700 (m)

0.350

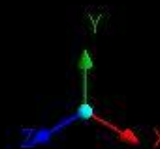



Simulation Definition

Simulation Data

Problem Type

In a single phase simulation only one fluid is present. In general the fluid is a pure substance, which is a material with specified physical properties.

Fluid Data

Select a single fluid.

Fluid ...

Mesh Data

Mesh File Available Volumes 

< Back

Next >

Cancel

View 1 ▾

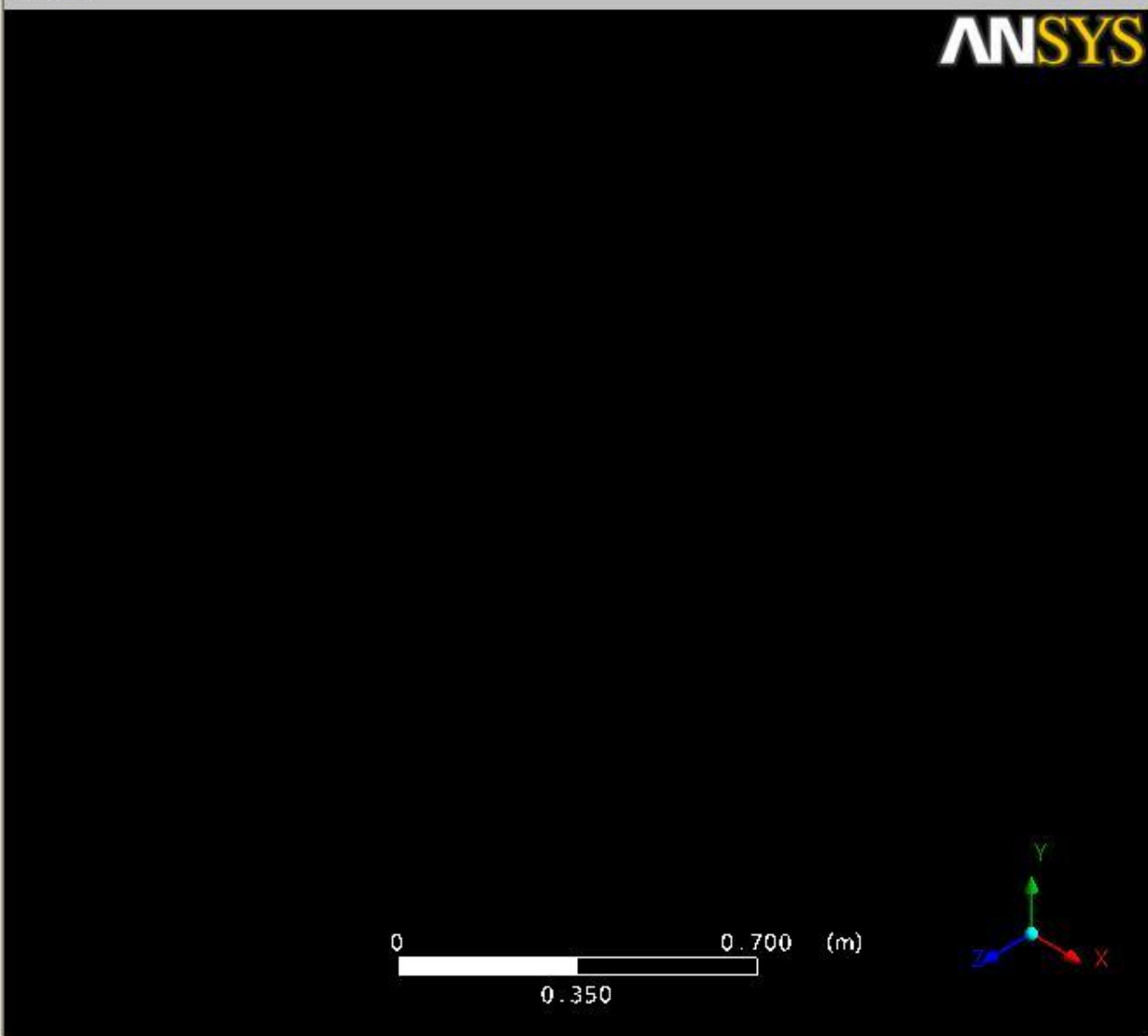

File Edit Session Insert Tools Help

- New Simulation... Ctrl+N
- Open Simulation... Ctrl+O
- Close Ctrl+W
- Save Simulation Ctrl+S
- Save Simulation As...**
- Import Mesh...
- Reload Mesh Files
- Write Solver File...
- Import CCL...
- Export CCL...
- Print... Ctrl+P
- Recent Simulation Files
- Recent CCL Files
- Recent Session Files
- Quit Ctrl+Q



View 1

ANSYS

the fluid is present. In
which is a material with

s

Available Volumes

< Back

Next >

Cancel

0 0.700 (m)

0.350

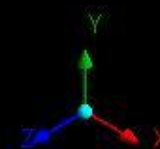



Simulation Definition

Simulation Data

Problem Type

In a single phase simulation only one fluid is present. In general the fluid is a pure substance, which is a material with specified physical properties.

Fluid Data

Select a single fluid.

Fluid

Mesh Data

Mesh File

Available Volumes

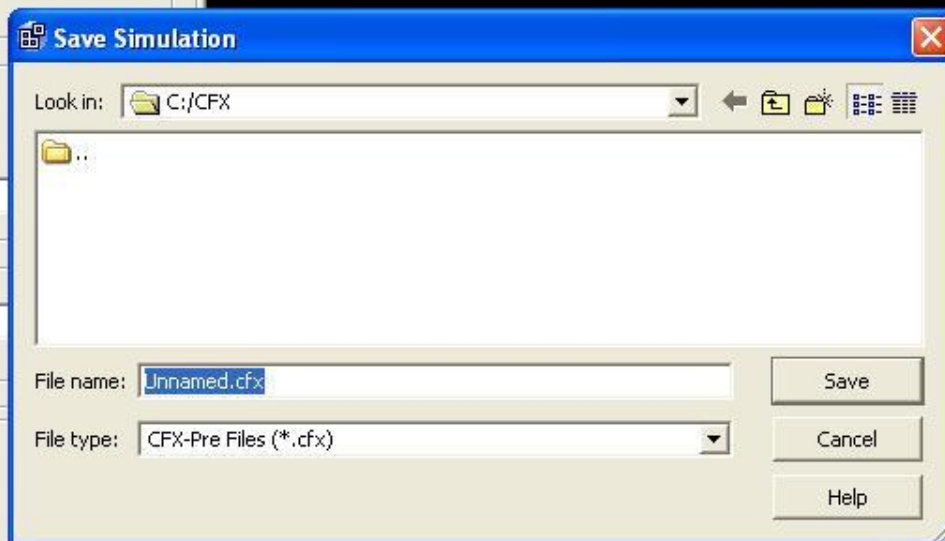

View 1

ANSYS

< Back

Next >

Cancel

0 0.700 (m)

0.350

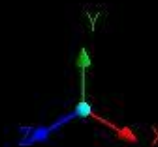



Simulation Definition

Simulation Data

Problem Type

In a single phase simulation only one fluid is present. In general the fluid is a pure substance, which is a material with specified physical properties.

Fluid Data

Select a single fluid.

Fluid

Mesh Data

Mesh File

Available Volumes

View 1

ANSYS

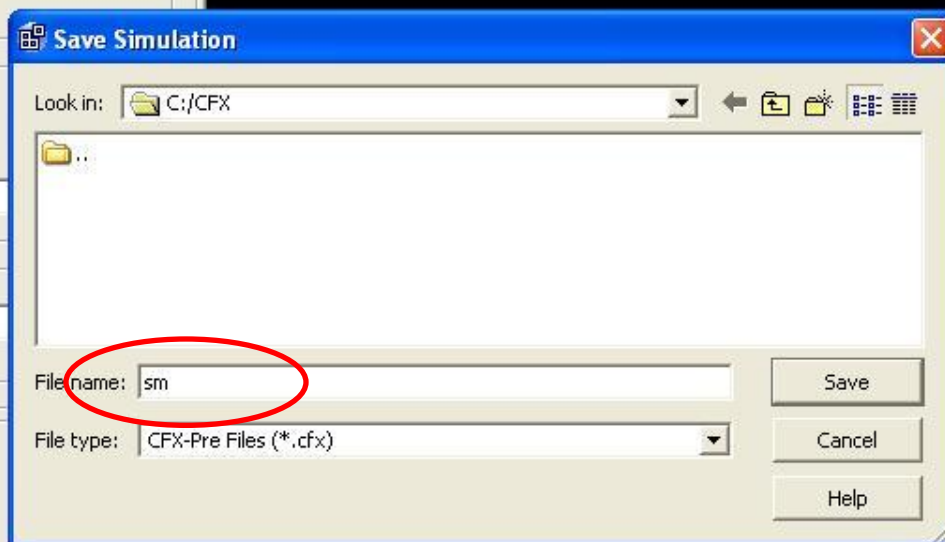

< Back

Next >

Cancel

0 0.700 (m)

0.350

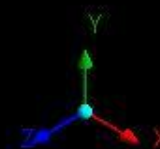



Simulation Definition

Simulation Data

Problem Type

In a single phase simulation only one fluid is present. In general the fluid is a pure substance, which is a material with specified physical properties.

Fluid Data

Select a single fluid.

Fluid

Mesh Data

Mesh File

Available Volumes

View 1

ANSYS

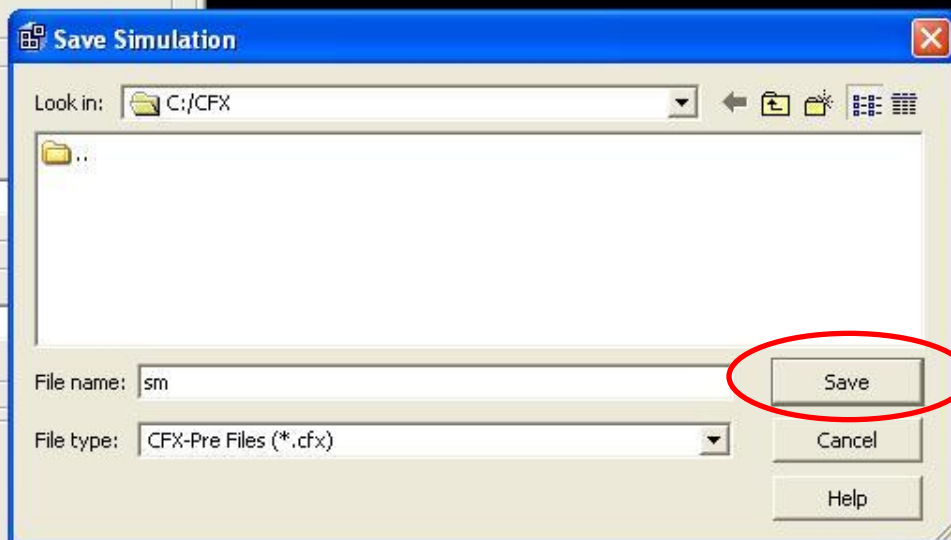

< Back

Next >

Cancel

0 0.700 (m)

0.350

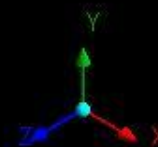



Simulation Definition

Simulation Data

Problem Type: Single Phase

In a single phase simulation only one fluid is present. In general the fluid is a pure substance, which is a material with specified physical properties.

Fluid Data

Select a single fluid.

Fluid: Air Ideal Gas ...

- Air Ideal Gas
- Air at 25 C
- Water**
- Water Ideal Gas

Mesh Data

Mesh File: [Folder Icon]

Available Volumes: [+]

< Back Next > Cancel



View 1

0 0.700 (m) 0.350



Simulation Definition

Simulation Data

Problem Type: Single Phase

In a single phase simulation only one fluid is present. In general the fluid is a pure substance, which is a material with specified physical properties.

Fluid Data

Select a single fluid.

Fluid: Water



Mesh Data

Mesh File: 

Available Volumes: +

< Back Next > Cancel

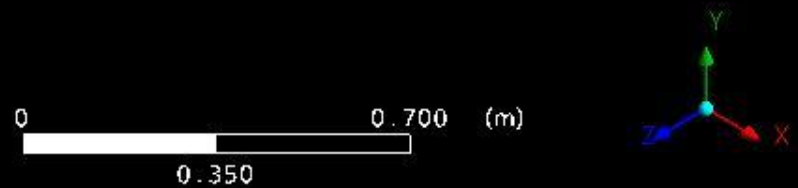
View 1





Simulation Definition

Simulation Data

Problem Type: Single Phase

In a single phase simulation only one fluid is present. In general the fluid is a pure substance, which is a material with specified physical properties.

Fluid Data

Select a single fluid.

Fluid: Water

Mesh Data

Mesh File: [Empty field]

Available Volumes: [Empty field]

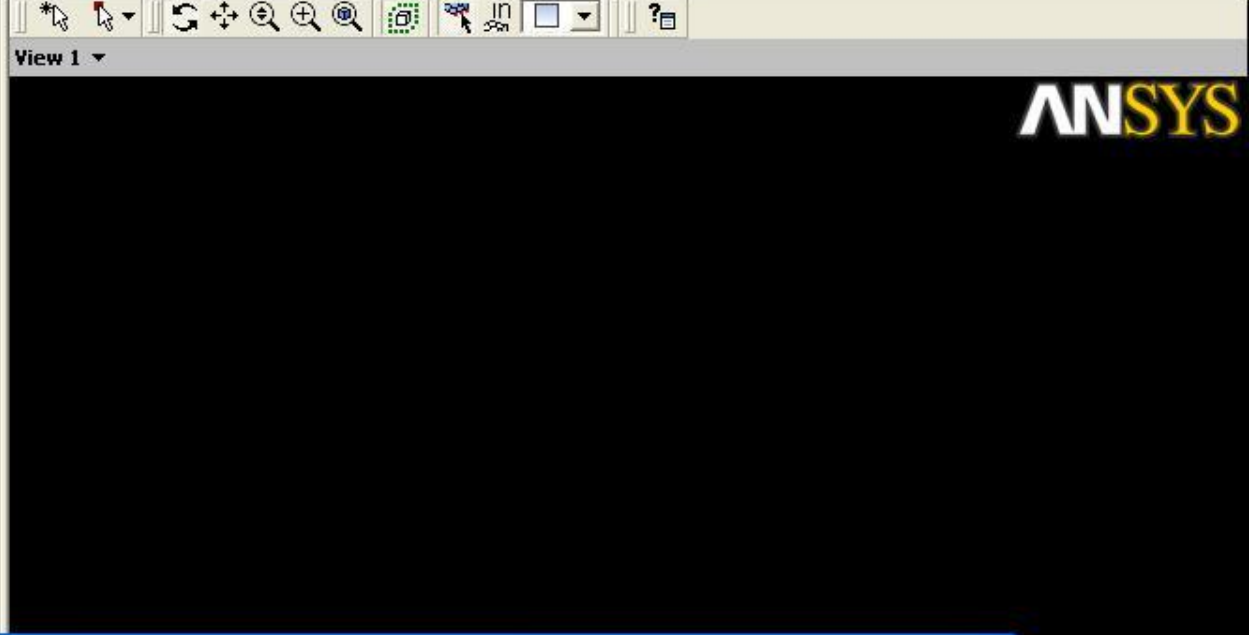

Import Mesh

Look in: C:/CFX

- ..
- sm.cfx
- StaticMixerMesh.gtm**

File name: "StaticMixerMesh.gtm"

File type: CFX Mesh (*.gtm *.cfx)

Buttons: Open, Cancel, Help, Revert to defaults



Simulation Definition

Simulation Data

Problem Type: Single Phase

In a single phase simulation only one fluid is present. In general the fluid is a pure substance, which is a material with specified physical properties.

Fluid Data

Select a single fluid.

Fluid: Water

Mesh Data

Mesh File

Available Volumes

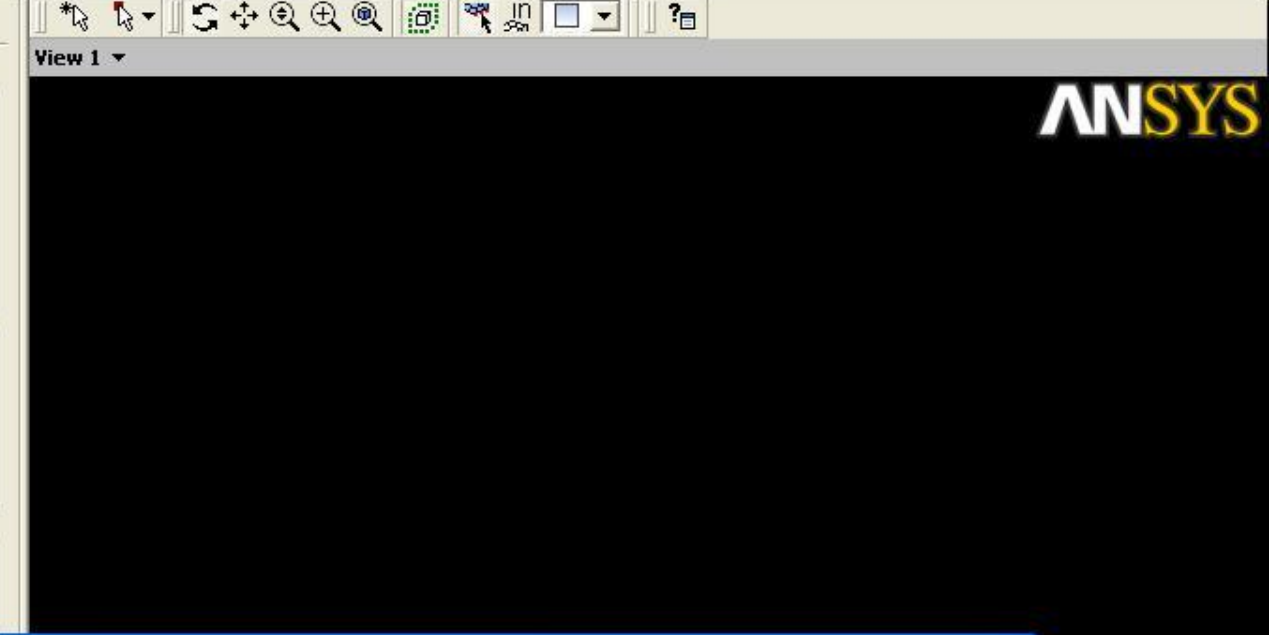

Import Mesh

Look in: C:/CFX

- ..
- sm.cfx
- StaticMixerMesh.gtm

File name: "StaticMixerMesh.gtm" **Open**

File type: CFX Mesh (*.gtm *.cfx)

Cancel

Help

Revert to defaults



Simulation Definition

Simulation Data

Problem Type:

In a single phase simulation only one fluid is present. In general the fluid is a pure substance, which is a material with specified physical properties.

Fluid Data

Select a single fluid.

Fluid: ...

Mesh Data

Mesh File:

Available Volumes:

< Back Next > Cancel

View 1

0 3.000 (m)

1.500



Simulation Definition

Simulation Data

Problem Type

In a single phase simulation only one fluid is present. In general the fluid is a pure substance, which is a material with specified physical properties.

Fluid Data

Select a single fluid.

Fluid

Mesh Data

Mesh File

Available Volumes

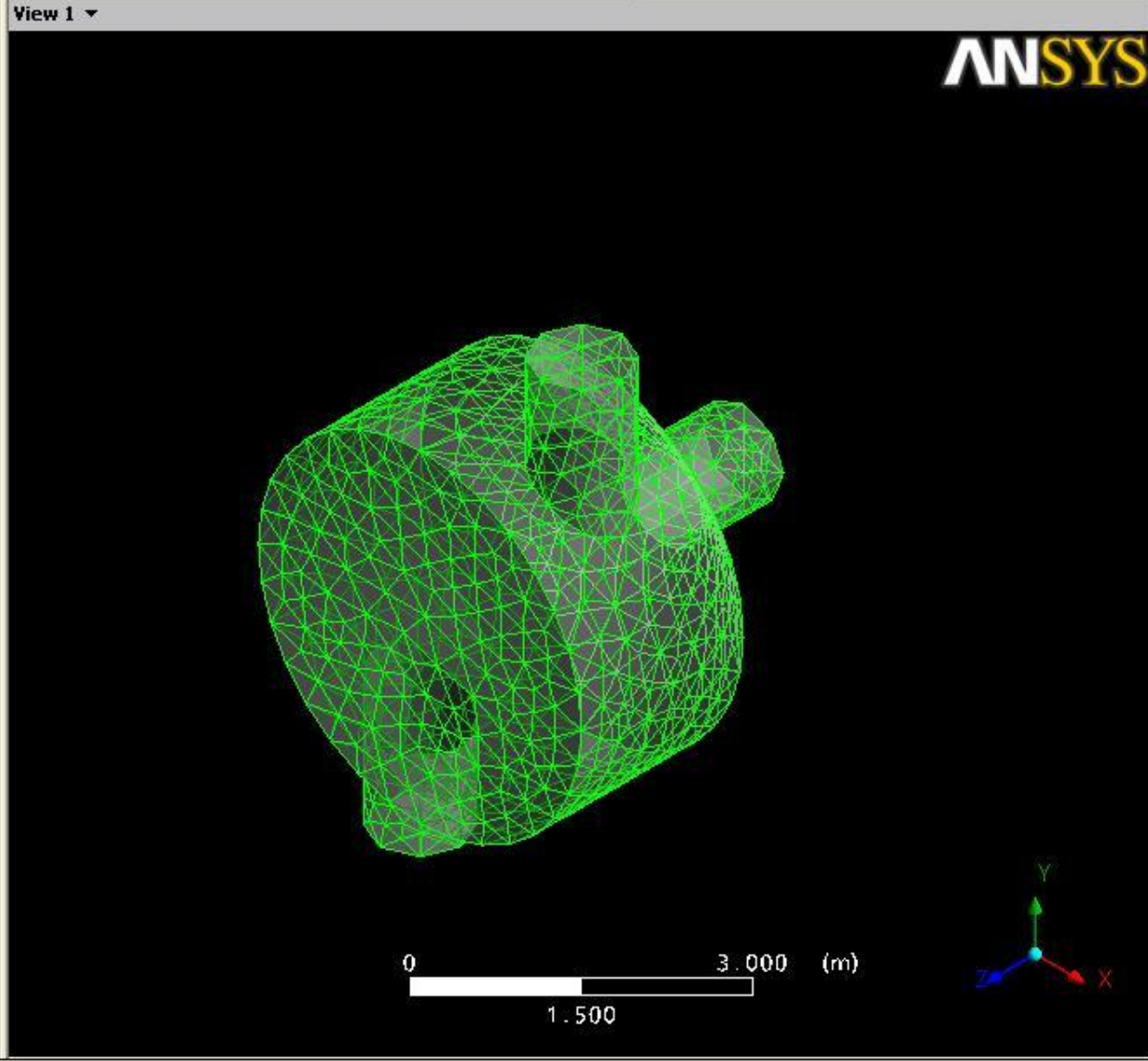

< Back **Next >** Cancel



Physics Definition

Simulation Type

Type:

Model Data

Reference Pressure:

Heat Transfer:

Turbulence:

< Back Next > Cancel

View 1

0 3.000 (m)

1.500

0%



Physics Definition

Simulation Type

Type:

Model Data

Reference Pressure:

Heat Transfer:

Turbulence:

< Back Next > Cancel

View 1

ANSYS

0 3.000 (m) 1.500



Physics Definition

Simulation Type

Type:

Model Data

Reference Pressure:

Heat Transfer:

Turbulence:

< Back Next > Cancel



View 1 ▾

ANSYS

0 3.000 (m)
1.500



Physics Definition

Simulation Type

Type:

Model Data

Reference Pressure:

Heat Transfer:

Turbulence:

< Back Next > Cancel



View 1 ▾

ANSYS

0 3.000 (m)

1.500

0%



Physics Definition

Simulation Type

Type:

Model Data

Reference Pressure:

Heat Transfer:

Turbulence:

< Back Next > Cancel

View 1

0 3.000 (m)

1.500



Physics Definition

Simulation Type

Type: Steady State

Model Data

Reference Pressure: 1 [atm]

Heat Transfer: None

Turbulence: k-Epsilon

< Back Next > Cancel

View 1

ANSYS

- Create New View...
- Delete View...
- Predefined Camera
 - Isometric View (Y up)
 - Isometric View (X up)
 - Isometric View (Z up)
 - View Towards +X
 - View Towards -X
 - View Towards +Y
 - View Towards -Y
 - View Towards +Z
 - View Towards -Z
- Fit View
- Projection
 - Isometric View (Z up)
- Default Legend
- Axis
- Ruler
- Print...
- Viewer Options...

0 3.000 (m) 1.500



Physics Definition

Simulation Type

Type:

Model Data

Reference Pressure:

Heat Transfer:

Turbulence:

< Back Next > Cancel

View 1

0 2.000 (m)

1.000



Physics Definition

Simulation Type

Type:

Model Data

Reference Pressure:

Heat Transfer:

Turbulence:

< Back Next > Cancel

View 1

- Create New View...
- Delete View
- Predefined Camera**
 - Isometric View (Y up)
 - Isometric View (X up)
 - Isometric View (Z up)**
- Fit View
- Projection
 - View Towards +X
 - View Towards -X
 - View Towards +Y
 - View Towards -Y
 - View Towards +Z
 - View Towards -Z
- Default Legend
- Axis
- Ruler
- Print...
- Viewer Options...

0 2.000 (m)

1.000



Physics Definition

Simulation Type

Type:

Model Data

Reference Pressure:

Heat Transfer:

Turbulence:

< Back Next > Cancel

View 1

ANSYS

0 3.000 (m) 1.500



Physics Definition

Simulation Type

Type

Model Data

Reference Pressure Heat Transfer Turbulence

- None
- Thermal Energy
- Total Energy

View 1 ▾

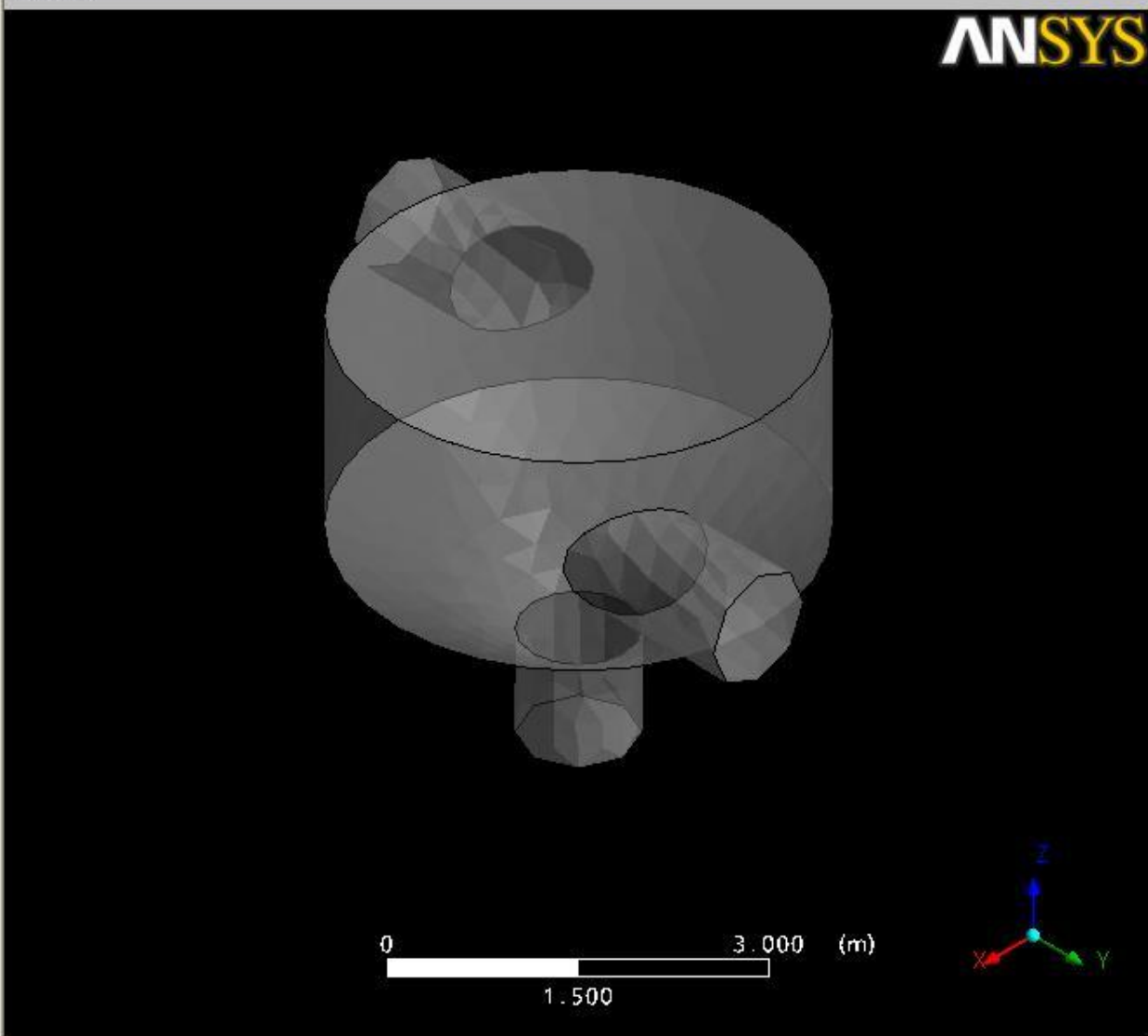

< Back

Next >

Cancel



Physics Definition

Simulation Type

Type

Model Data

Reference Pressure Heat Transfer Turbulence

View 1 ▾

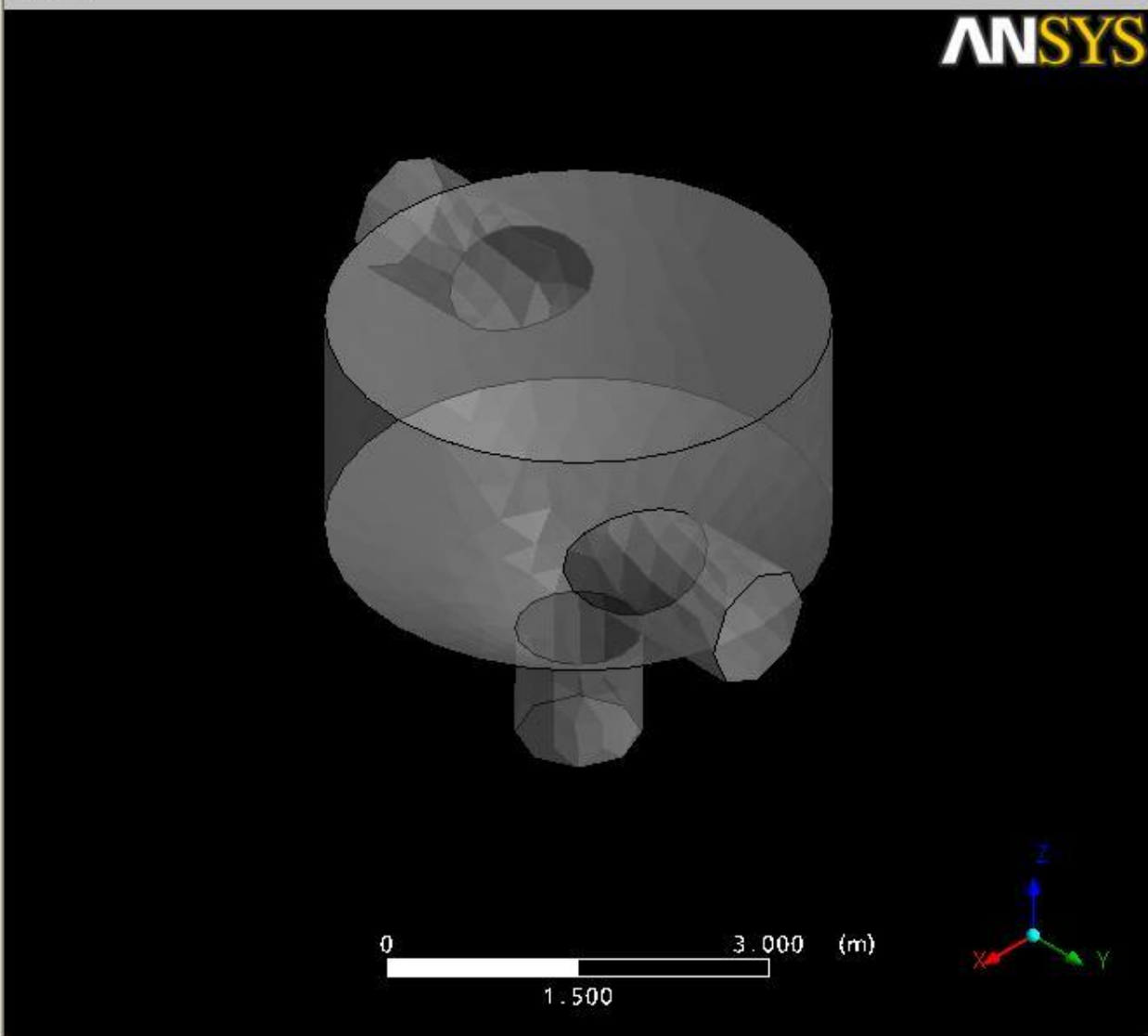

< Back

Next >

Cancel



Boundary Definition

- Inlet
- Outlet

Boundary Data

Boundary Type:

Location: ...

Flow Specification

Option:

Normal Speed:

Temperature Specification

Static Temperature:

< Back Next > Cancel

View 1

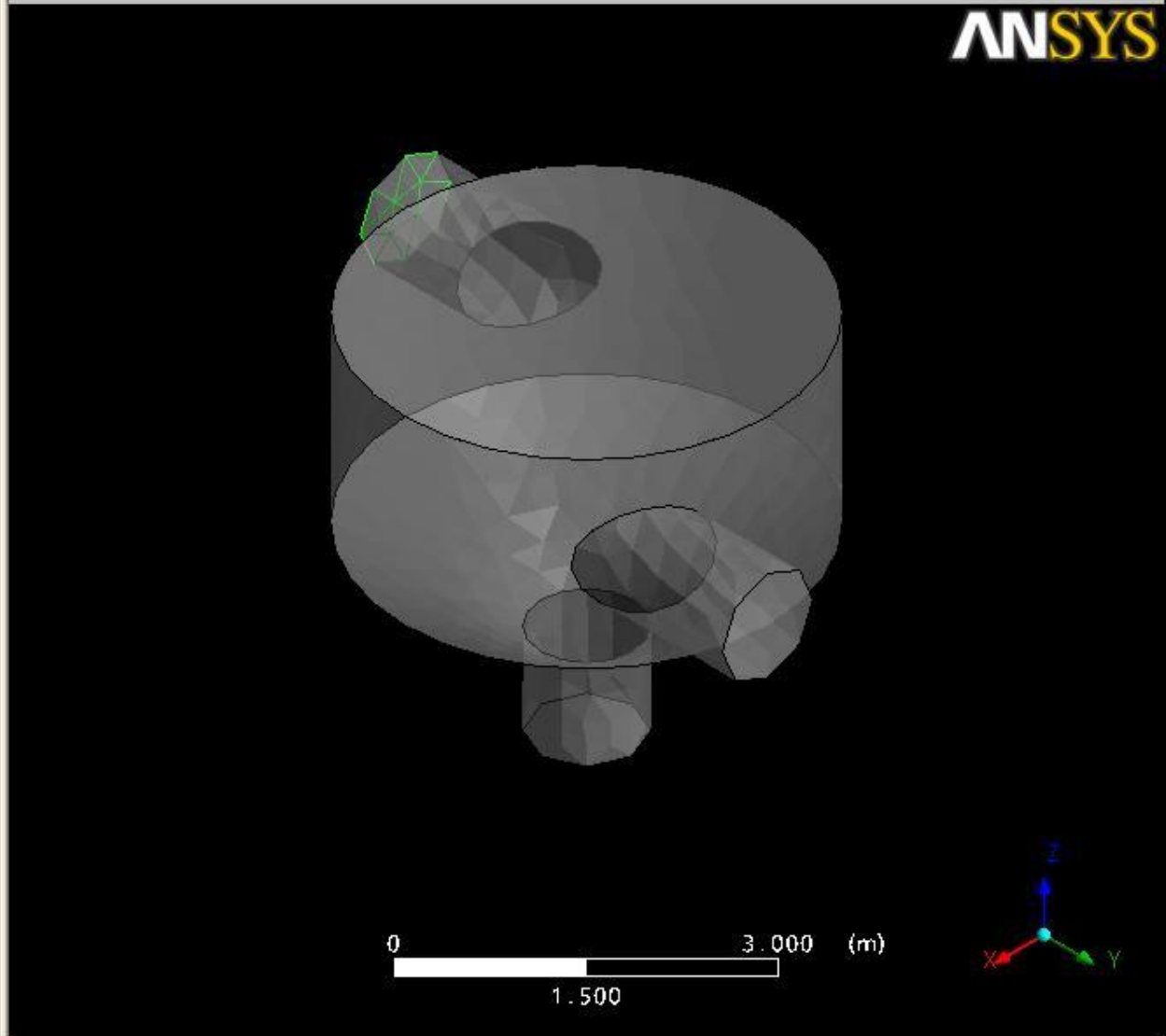



Boundary Definition

- Inlet
- Outlet

New ...
Delete

Boundary Data

Boundary Type: Inlet

Location: in1

Flow Specification

Option: Normal Speed

Normal Speed: 1 [m s⁻¹]

Temperature Specification

Static Temperature: 20 [C]

< Back Next > Cancel

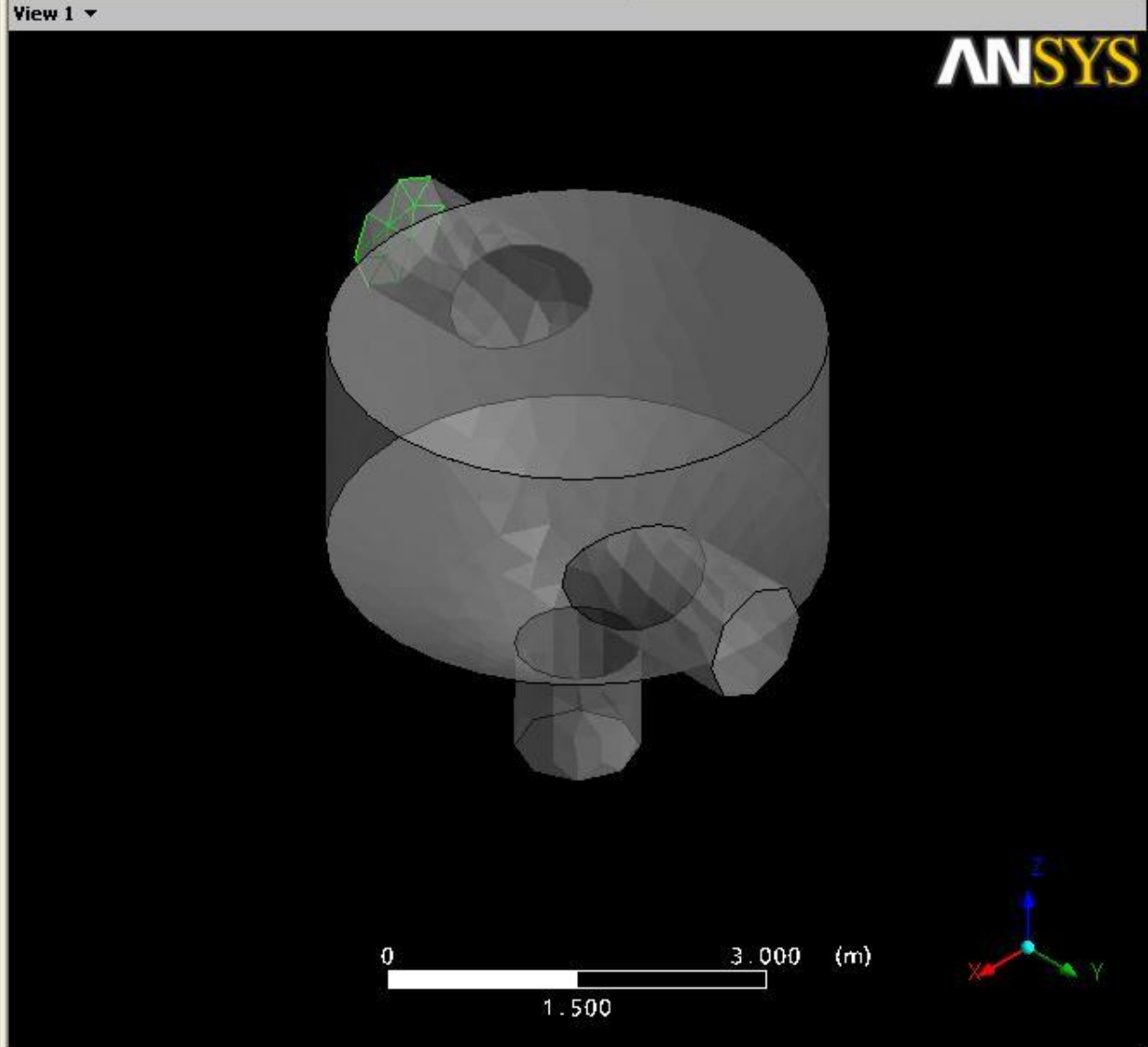



Boundary Definition

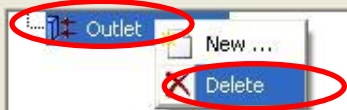

Boundary Data

Boundary Type Location ...

Flow Specification

Option Relative Pressure

< Back

Next >

Cancel

View 1 ▾

ANSYS

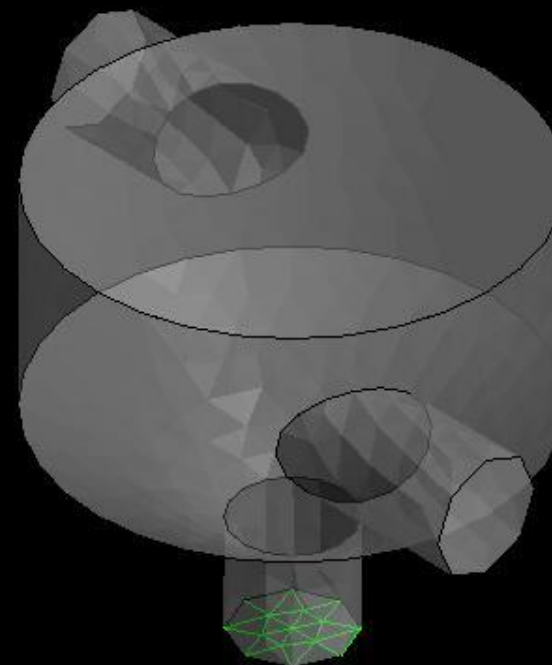

0 3 000 (m)

1.500

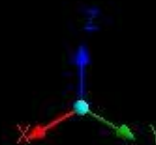



Boundary Definition

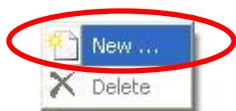

View 1 ▾

ANSYS

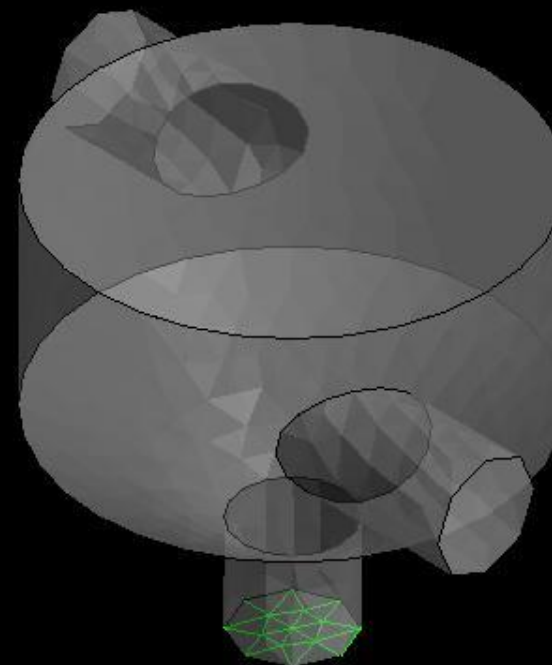

< Back

Next >

Cancel



Boundary Definition

New Boundary [?] [X]

Name

Domain

OK Cancel

View 1 ▾

ANSYS

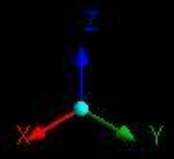
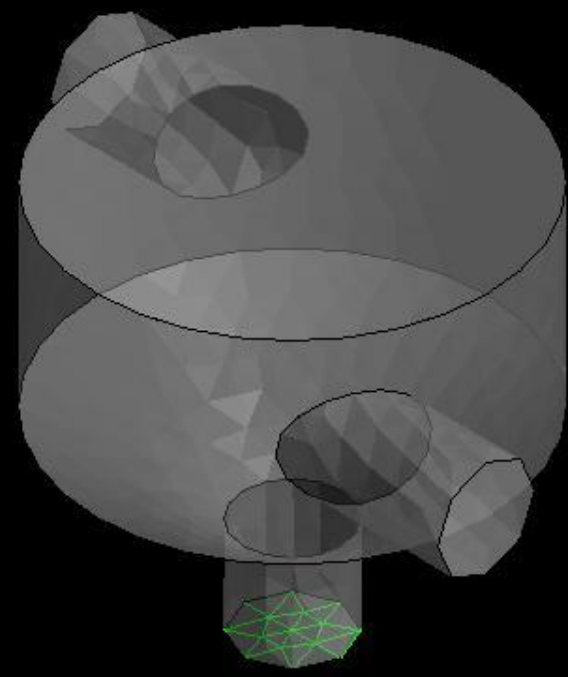

< Back Next > Cancel



Boundary Definition

in1

Boundary Data

Boundary Type: Inlet

Location: in1

Flow Specification

Option: Normal Speed

Normal Speed: 2 [m s⁻¹]

Temperature Specification

Static Temperature: 20 [C]

< Back Next > Cancel

View 1

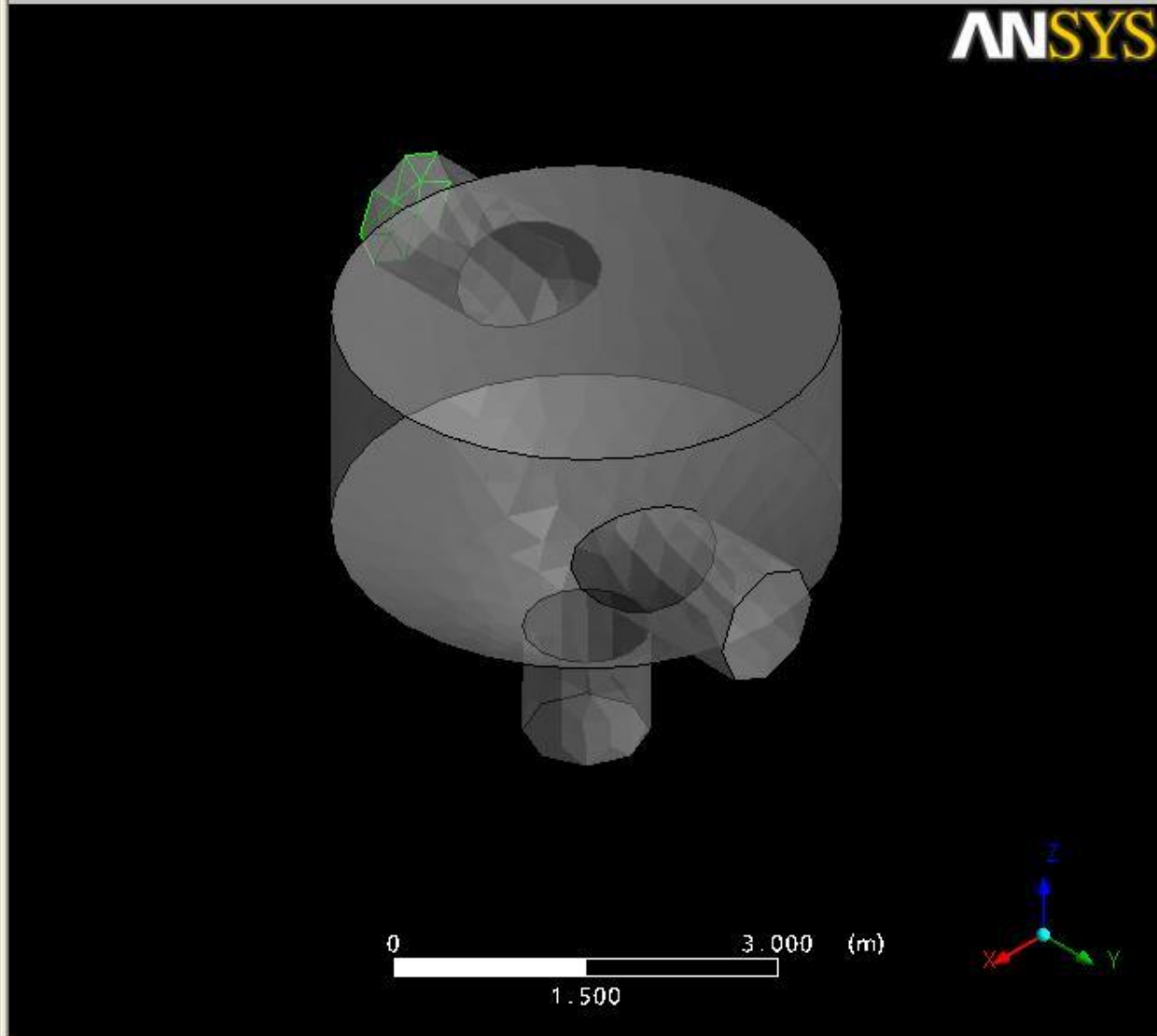



Boundary Definition

in1

Boundary Data

Boundary Type: Inlet

Location: in1

Flow Specification

Option: Normal Speed

Normal Speed: 2 [m s⁻¹]

Temperature Specification

Static Temperature: 315 [K]

< Back Next > Cancel

View 1

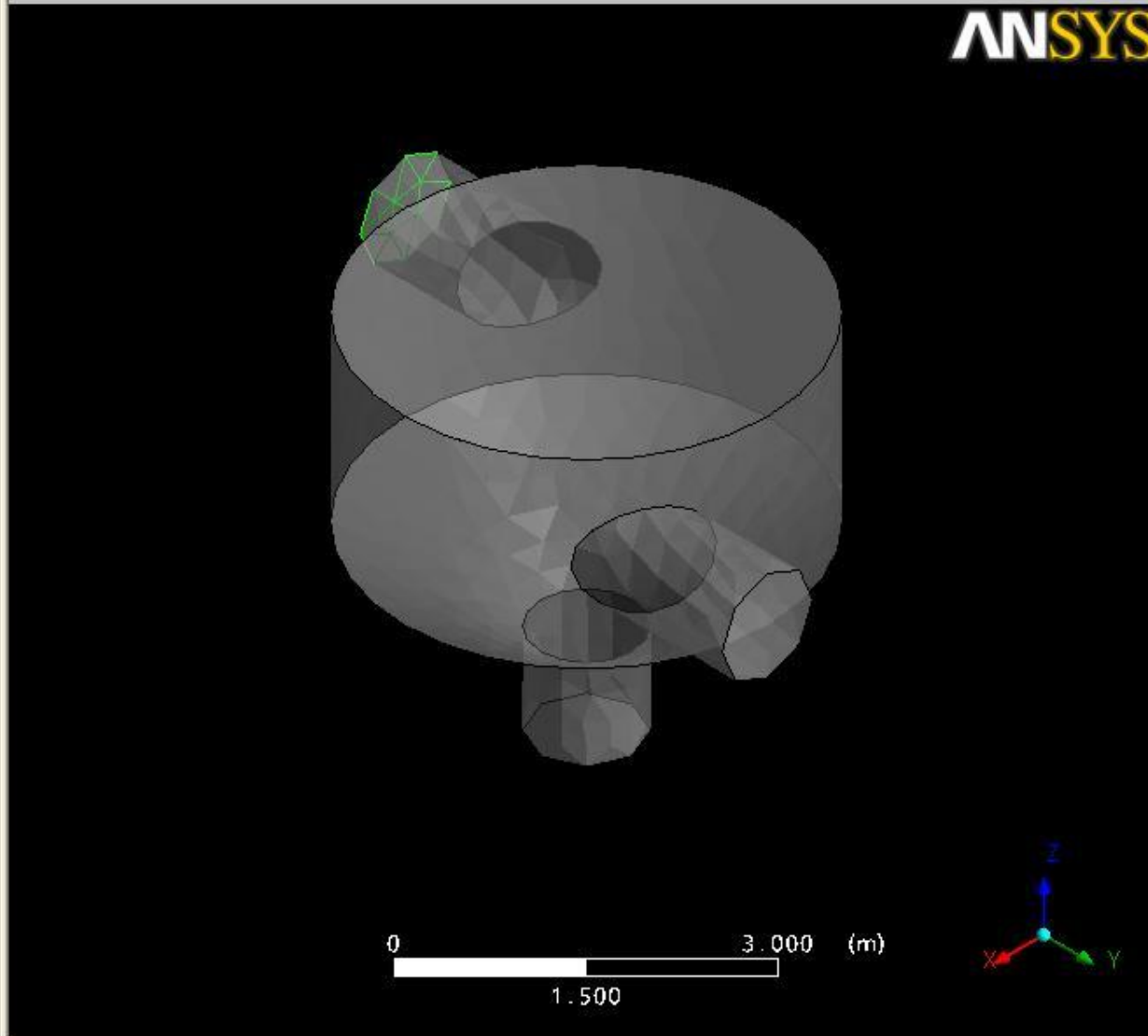



Boundary Definition

in1

New Boundary

Name

Domain

OK Cancel

Boundary Data

Boundary Type

Location

Flow Specification

Option

Normal Speed

Temperature Specification

Static Temperature

< Back Next > Cancel

View 1

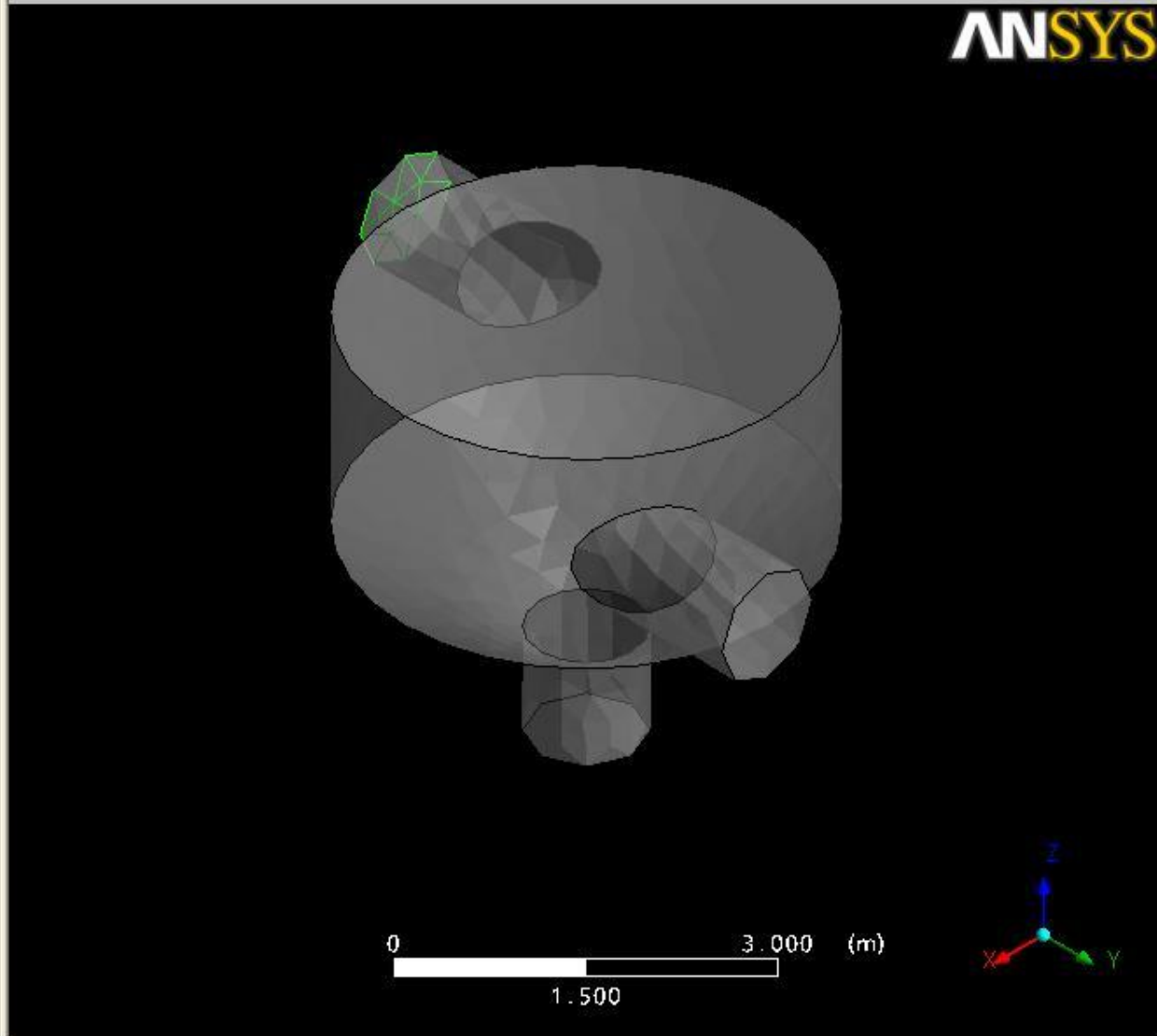



Boundary Definition

- in1
- in2

Boundary Data

Boundary Type: Inlet

Location: in2

Flow Specification

Option: Normal Speed

Normal Speed: 2 [m s⁻¹]

Temperature Specification

Static Temperature: 285 [K]

View 1

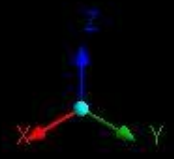
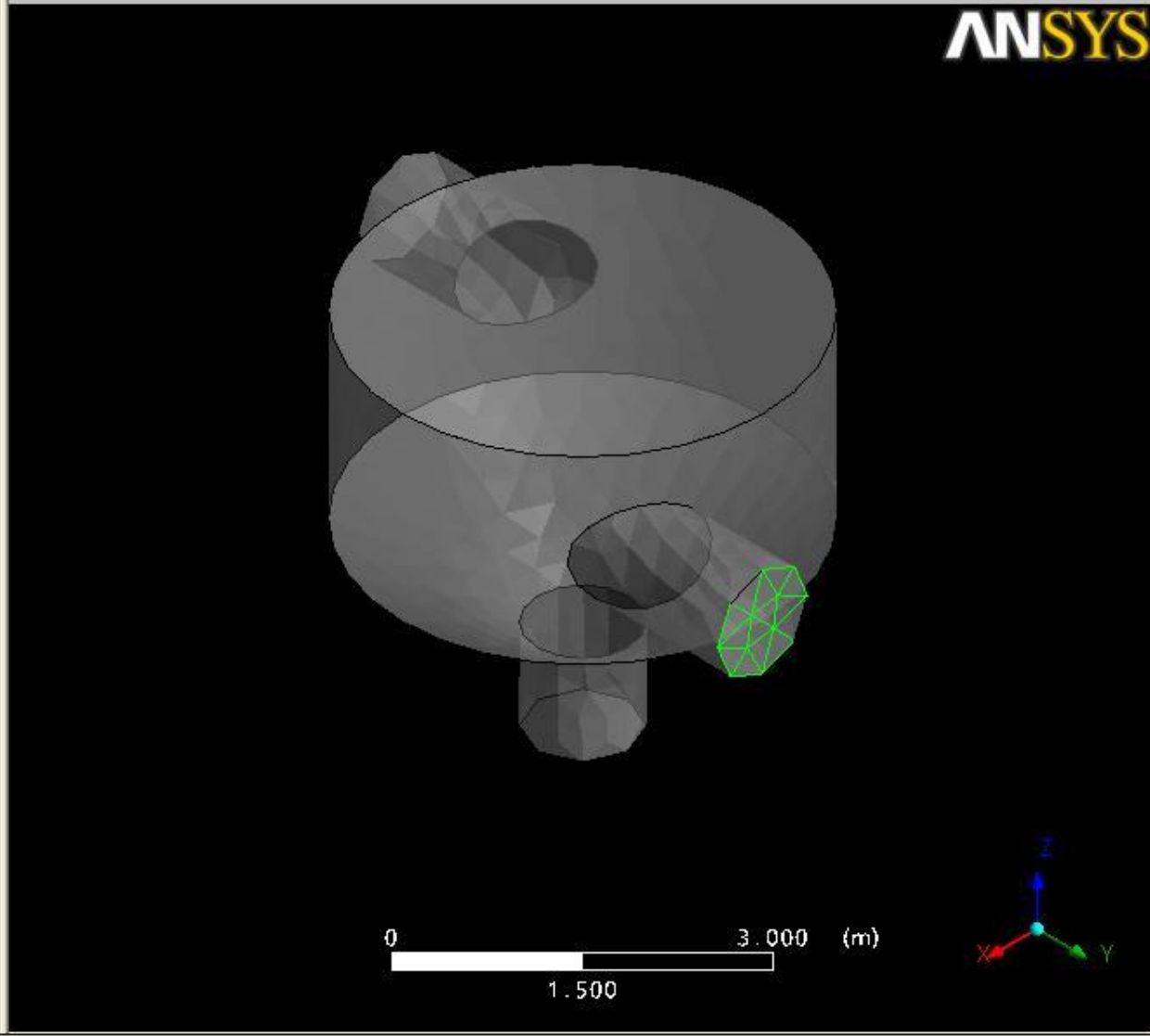

< Back Next > Cancel



Boundary Definition

- in1
- in2

New ...
Delete

Boundary Data

Boundary Type: Inlet
Location: in2

Flow Specification

Option: Normal Speed
Normal Speed: 2 [m s⁻¹]

Temperature Specification

Static Temperature: 285 [K]

< Back Next > Cancel

View 1

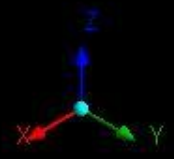
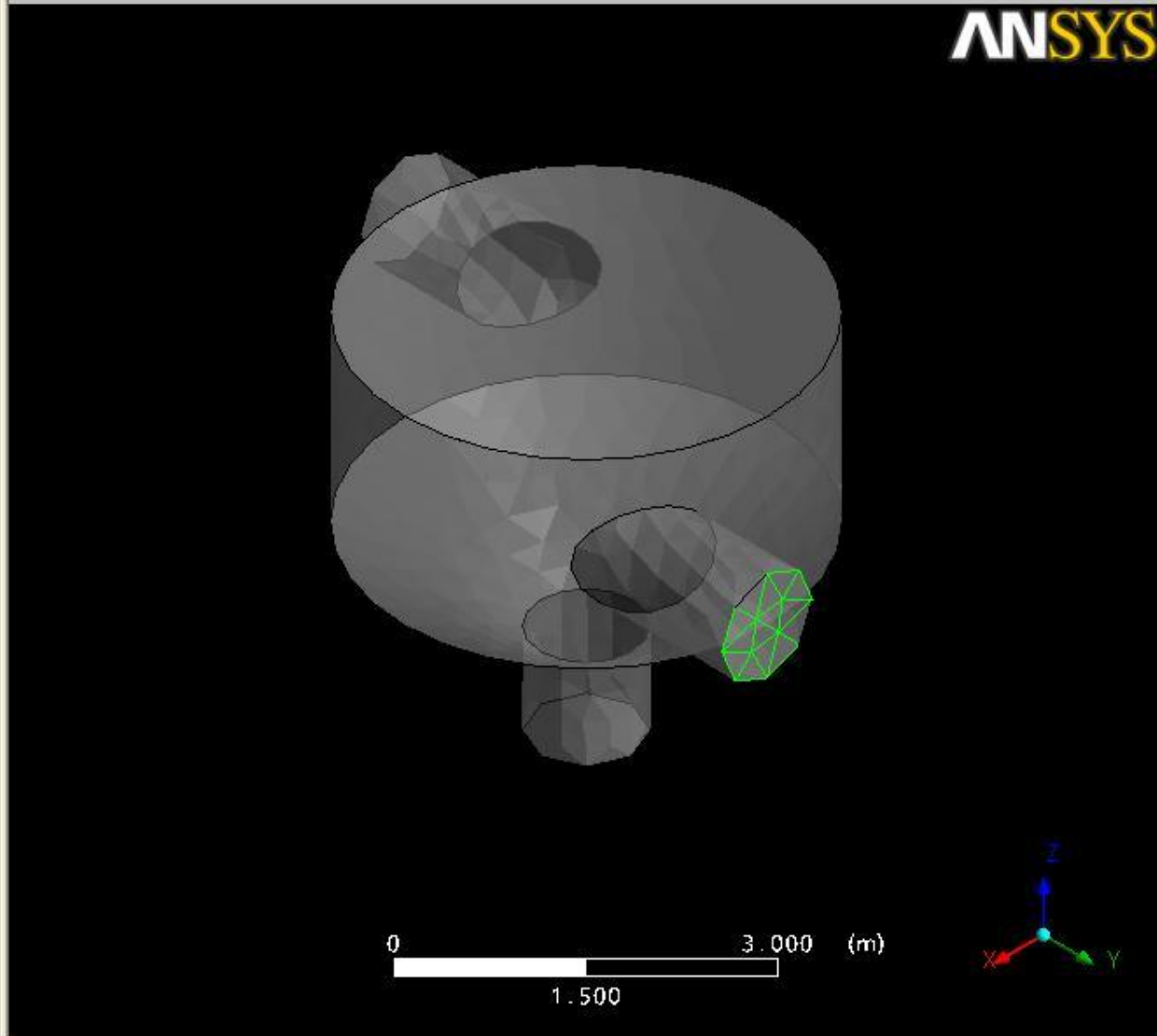



Boundary Definition

- in1
- in2

New Boundary

Name: out

Domain: Default Domain

OK Cancel

Boundary Data

Boundary Type: Inlet

Location: in2

Flow Specification

Option: Normal Speed

Normal Speed: 2 [m s⁻¹]

Temperature Specification

Static Temperature: 285 [K]

< Back Next > Cancel

View 1

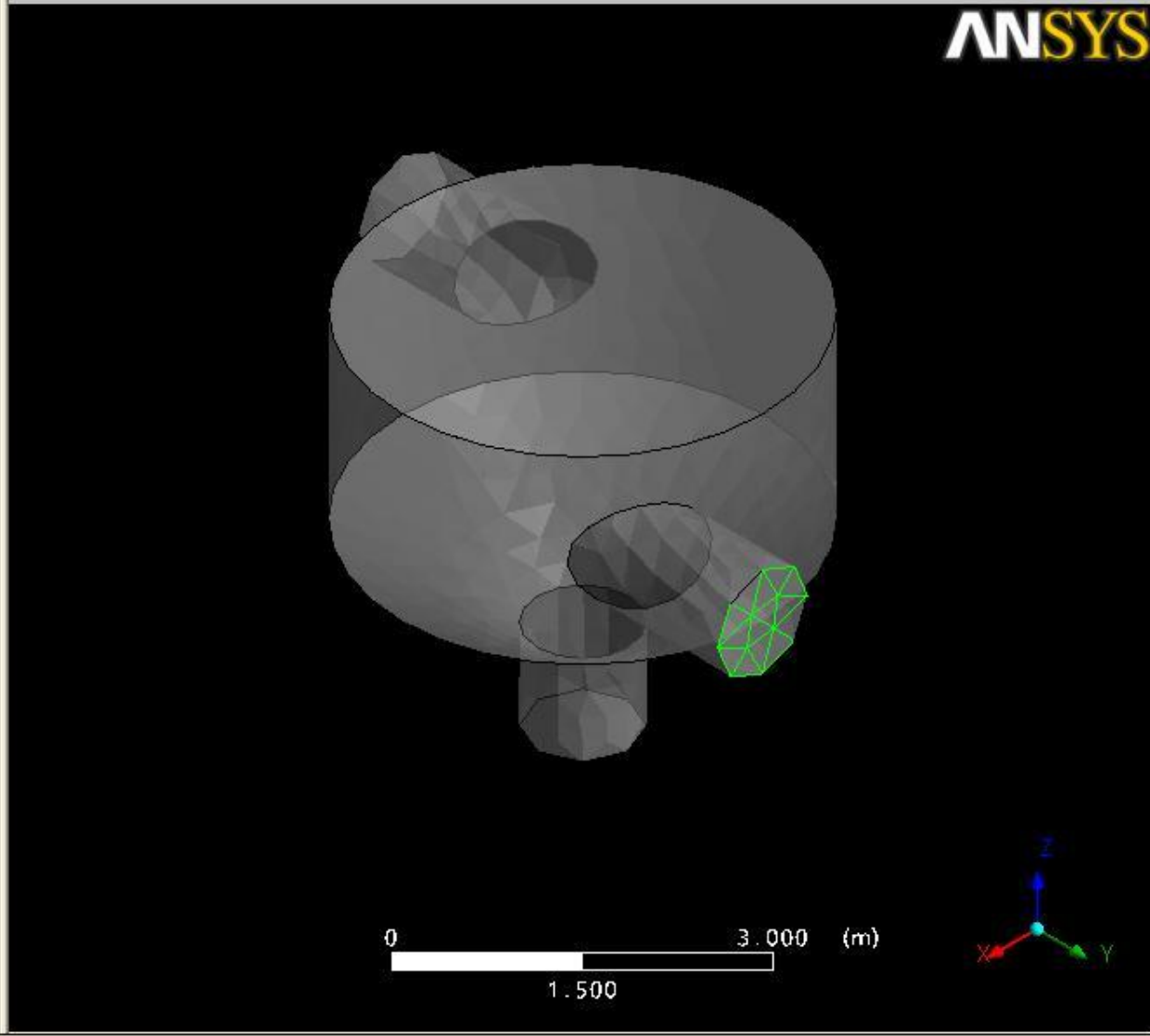



Boundary Definition

- in1
- in2
- out

Boundary Data

Boundary Type: **Outlet**

Location: out

Flow Specification

Option: Average Static Pressure

Relative Pressure: 0 [Pa]

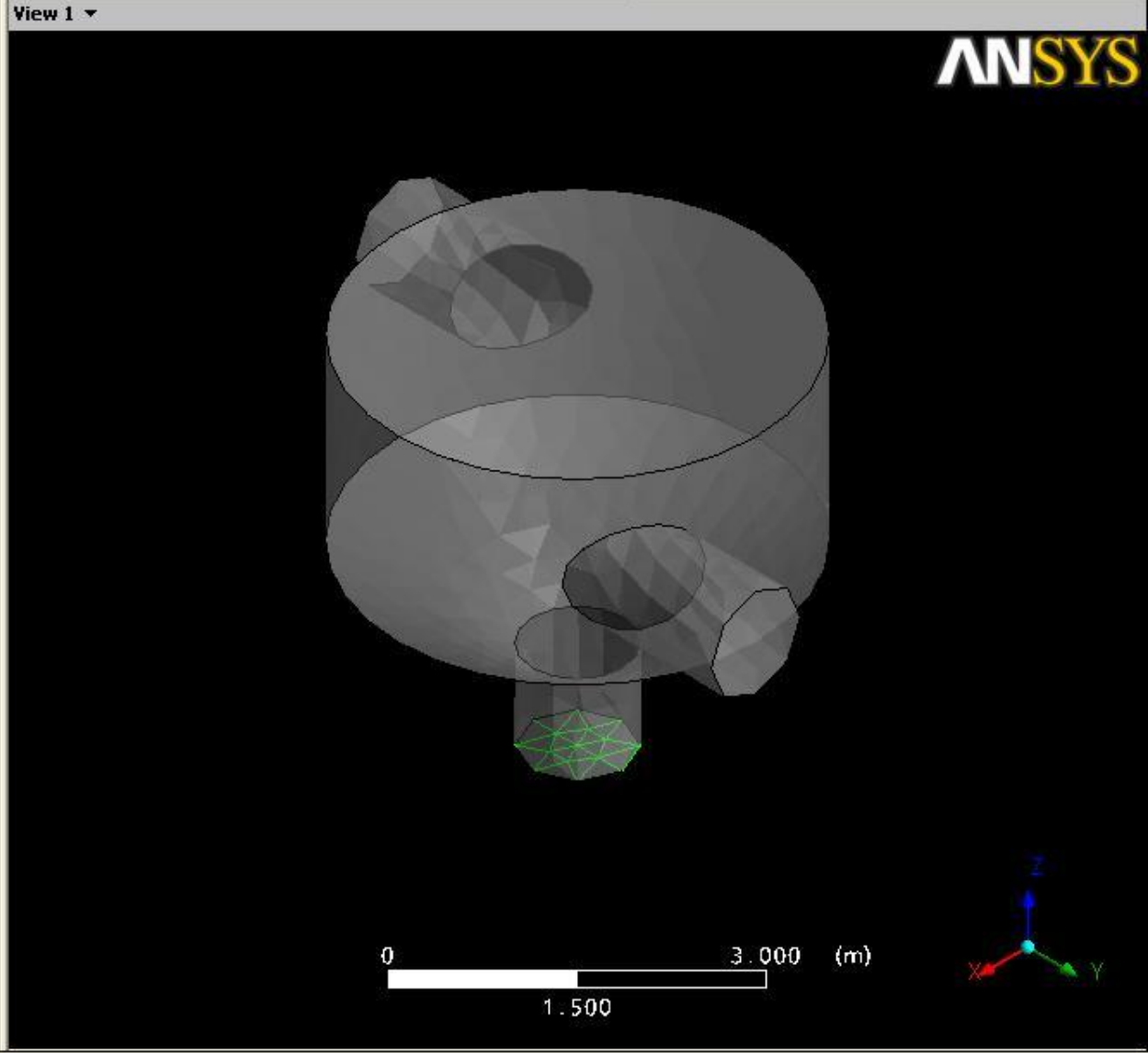

< Back Next > Cancel



Boundary Definition

- in1
- in2
- out

Boundary Data

Boundary Type:

Location: ...

Flow Specification

Option:

Relative Pressure:

< Back **Next >** Cancel

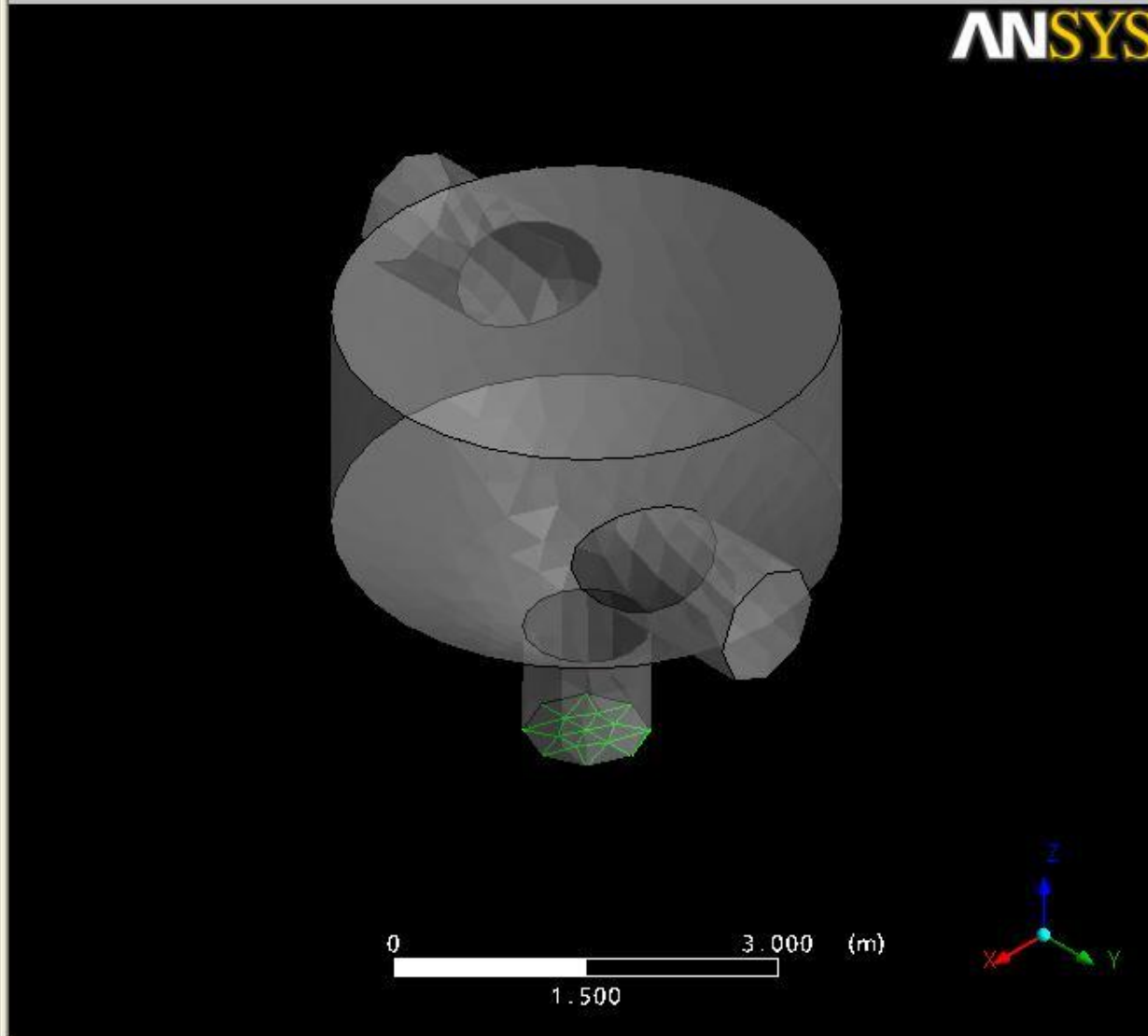
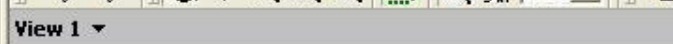



Final Operations

Operation: Start Solver 

Solver File Name: C:/CFX/sm

< Back Finish Cancel

View 1

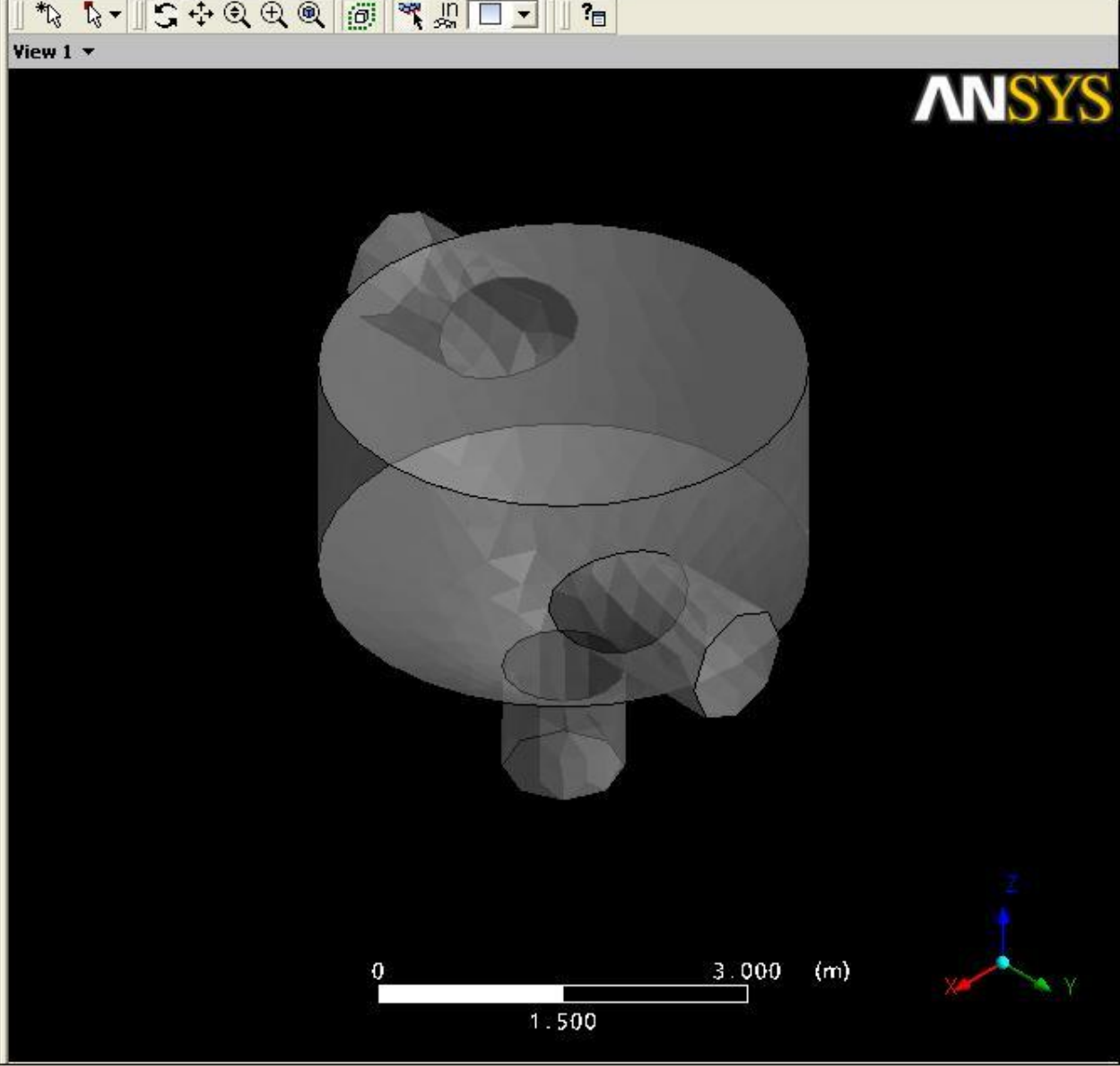

ANSYS

0 3.000 (m)
1.500

X Y Z



Final Operations

Operation: Start Solver

Solver File Name: Start Solver and Quit

Enter General Mode

< Back Finish Cancel

View 1

ANSYS

0 3.000 (m) 1.500



Final Operations

Operation

< Back **Finish** Cancel

View 1

ANSYS

0 3.000 (m)
1.500

X Y Z



Outline

- Mesh
 - StaticMixerMesh.gtm
- Simulation
 - Simulation Type
 - Default Domain
 - Default Domain Default
 - in1
 - in2
 - out
- Solver
 - Solution Units
 - Solver Control
 - Output Control
- Materials
- Reactions
- Expressions, Functions and Variables
 - Additional Variables
 - Expressions
 - User Functions
 - User Routines

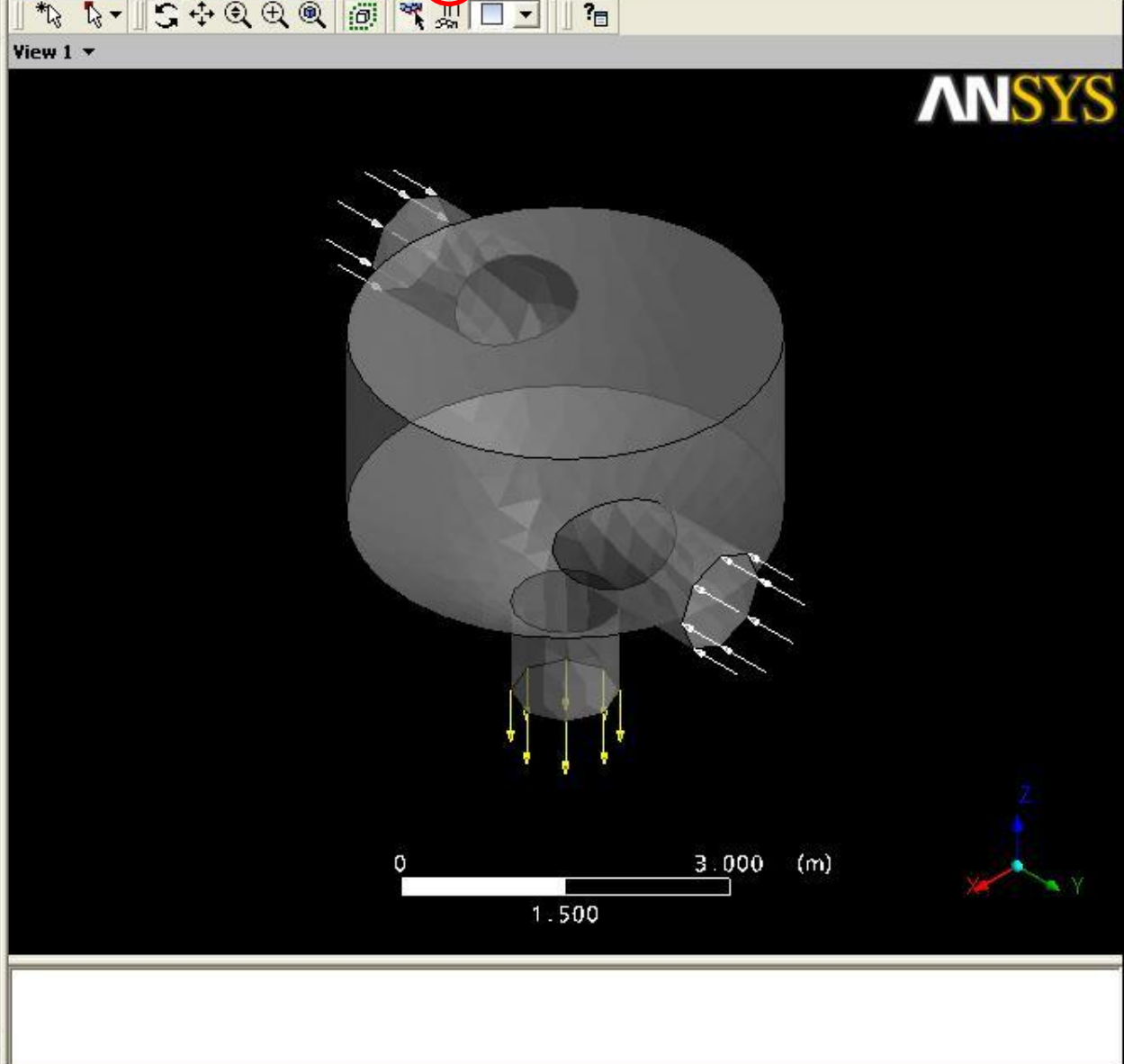

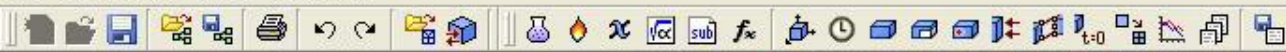

Outline Solver Control

Details of Solver Control

Basic Settings Equation Class Settings Advanced Options

Advection Scheme

Option Upwind

Convergence Control

Minimum Number of Iterations

Max. Iterations 100

Fluid Timescale Control

Timescale Control Physical Timescale

Physical Timescale 2 s

Convergence Criteria

Residual Type RMS

Residual Target 1.E-4

Conservation Target

Elapsed Time Control

Ok Apply Close

View 1

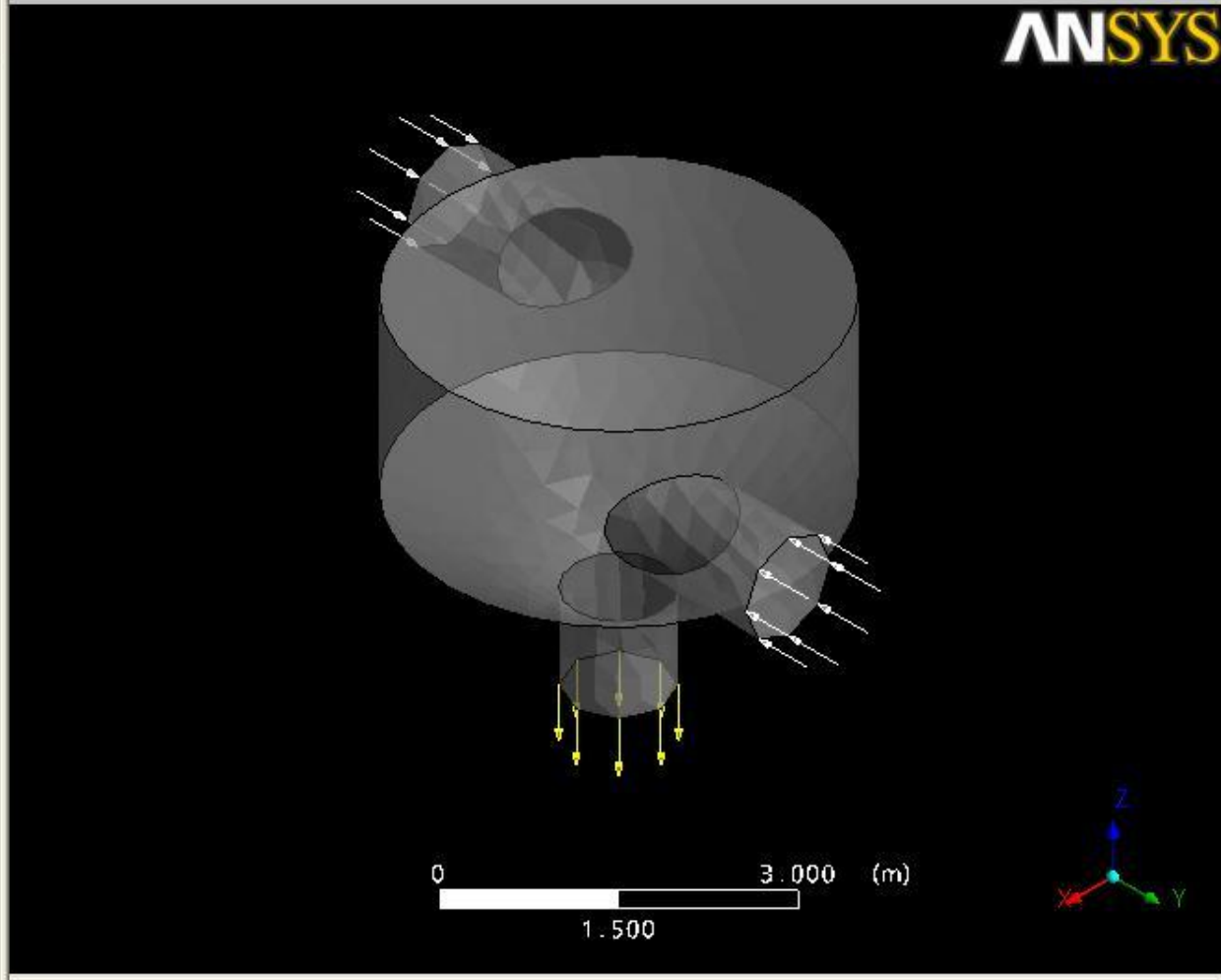



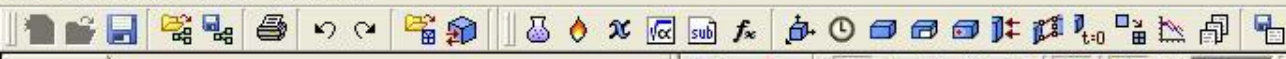

Outline

- Mesh
 - StaticMixerMesh.gtm
- Simulation
 - Simulation Type
 - Default Domain
 - Default Domain Default
 - in1
 - in2
 - out
- Solver
 - Solution Units
 - Solver Control
 - Output Control
- Materials
- Reactions
- Expressions, Functions and Variables
 - Additional Variables
 - Expression
 - User Function
 - User Route

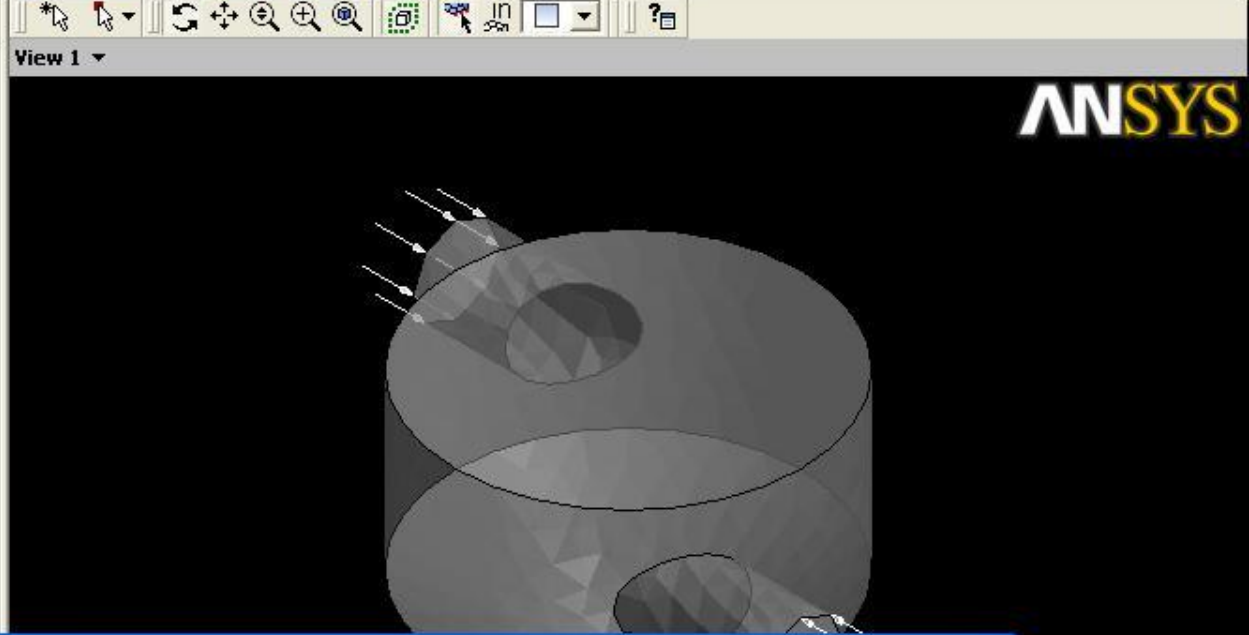

Write Solver File

Look in: C:/CFX

Start Solver Manager

Quit CFX-Pre

File name: sm.def

File type: CFX-Solver Files (*.def)

Save Cancel Help

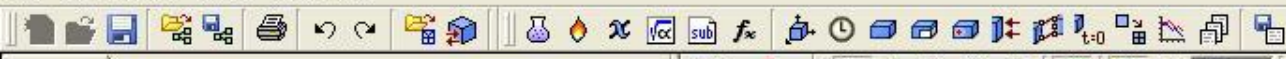

Outline

- Mesh
 - StaticMixerMesh.gtm
- Simulation
 - Simulation Type
 - Default Domain
 - Default Domain Default
 - in1
 - in2
 - out
- Solver
 - Solution Units
 - Solver Control
 - Output Control
- Materials
- Reactions
- Expressions, Functions and Variables
 - Additional Variables
 - Expression
 - User Function
 - User Route

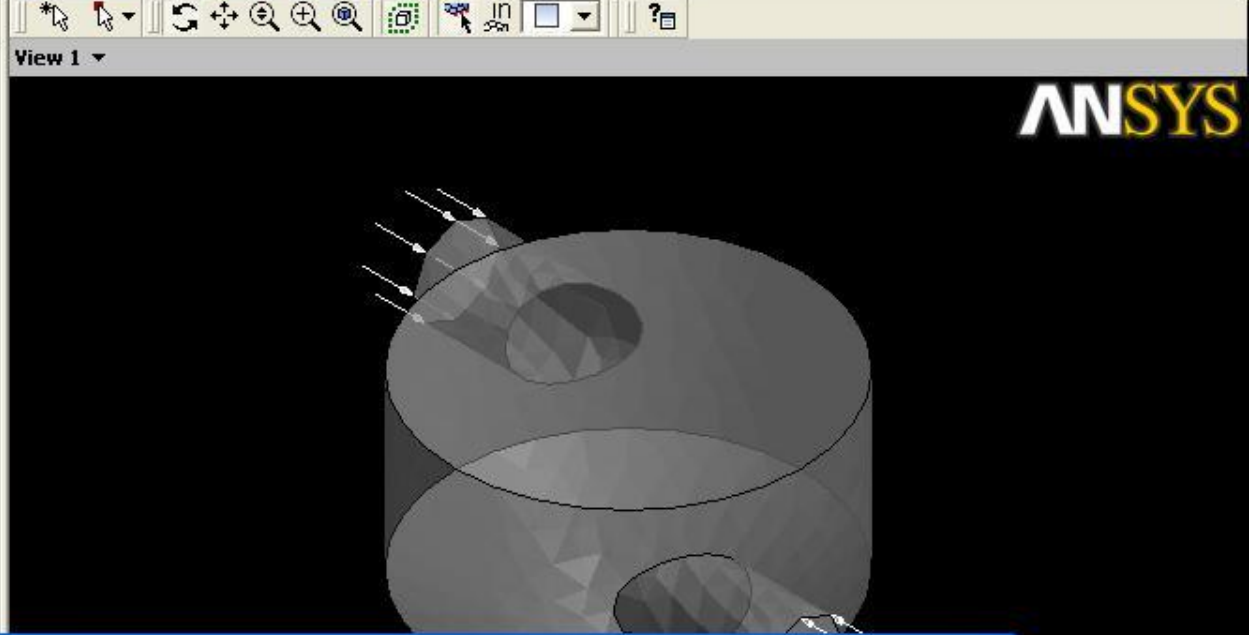

Write Solver File

Look in: C:/CFX

File name: sm.def

File type: CFX-Solver Files (*.def)

Write Solver File

Quit CFX-Pre

Buttons: Save, Cancel, Help

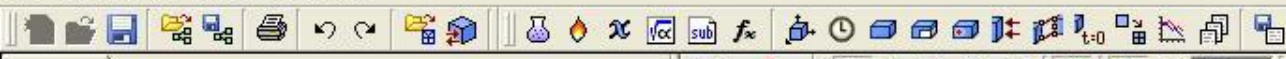

Outline

- Mesh
 - StaticMixerMesh.gtm
- Simulation
 - Simulation Type
 - Default Domain
 - Default Domain Default
 - in1
 - in2
 - out
- Solver
 - Solution Units
 - Solver Control
 - Output Control
- Materials
- Reactions
- Expressions, Functions and Variables
 - Additional Variables
 - Expression
 - User Function
 - User Route

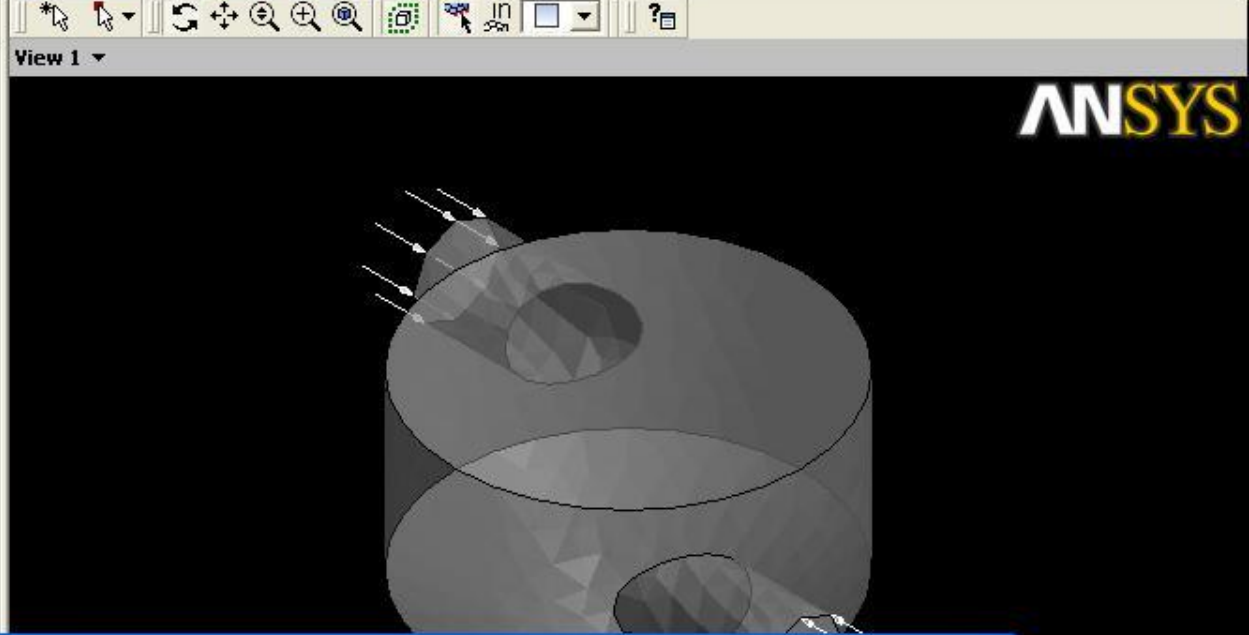

Write Solver File

Look in: C:/CFX

File name: sm.def

File type: CFX-Solver Files (*.def)

Quit CFX-Pre

Save

Cancel

Help

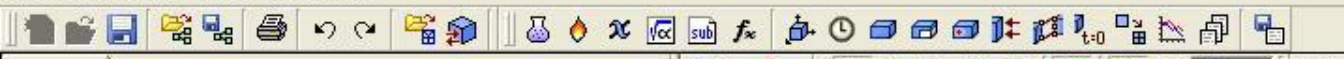

Outline

- Mesh
 - StaticMixerMesh.gtm
- Simulation
 - Simulation Type
 - Default Domain
 - Default Domain Default
 - in1
 - in2
 - out
- Solver
 - Solution Units
 - Solver Control
 - Output Control
- Materials
- Reactions
- Expressions, Functions and Variables
 - Additional Variables
 - Expressions
 - User Functions
 - User Routines

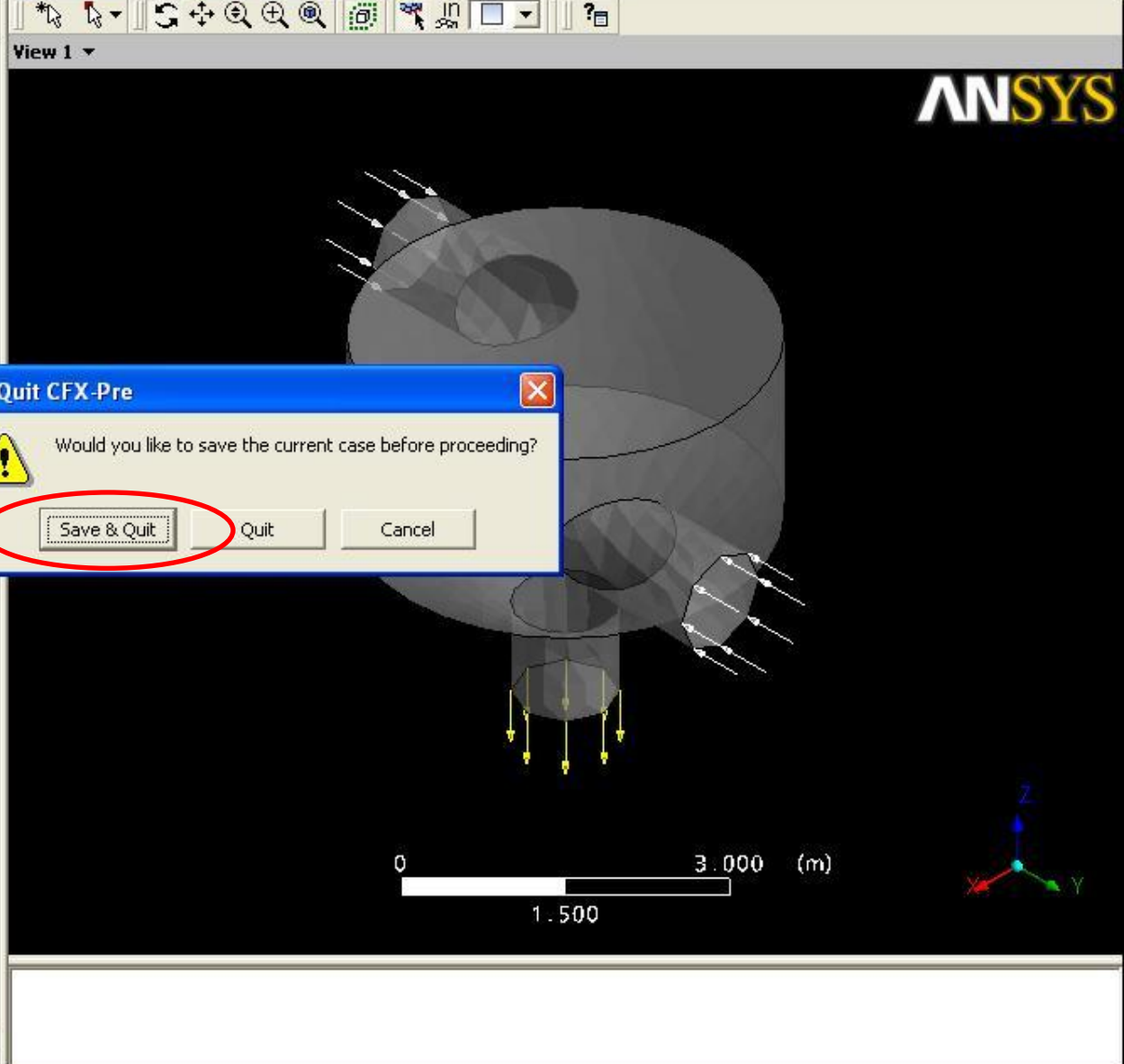

Quit CFX-Pre

Would you like to save the current case before proceeding?

putty060

Far Manager

ANSYS CFX-11.0 Launcher (on COMP1)

File Edit CFX Show Tools User Help

CFX-Pre 11.0 CFX-Solver 11.0 CFX-Post 11.0

Working Directory C:/CFX

Корзина



ANSYS CFX-11.0 Launcher (on COMP1)

File cfx

Файл Правка Вид Избранное Сервис Справка

Назад Поиск Папки

Адрес: C:\cfx

Папки

- Рабочий стол
- Мои документы
- Мой компьютер
- Диск 3,5 (A:)
- Локальный диск (C:)
 - ansys11sp1
 - cfx
 - Documents and Settings
 - new
 - Program Files
 - WINDOWS
- DVD-дисковод (D:)
- Панель управления
- Сетевое окружение
- Корзина

StaticMixerMesh.gtm
Файл "GTM"
292 КБ

sm.cfx
ANSYS CFX Pre- File
345 КБ

sm.def
ANSYS CFX Solver File
206 КБ

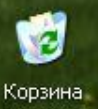



ANSYS CFX-11.0 Launcher (on COMP1)

File cfx

Файл Правка Вид Избранное Сервис Справка

Назад Поиск Папки

Адрес: C:\cfx

Папки

- Рабочий стол
- Мои документы
- Мой компьютер
- Диск 3,5 (A:)
- Локальный диск (C:)
 - ansys11sp1
 - cfx
 - Documents and Settings
 - new
 - Program Files
 - WINDOWS
 - DVD-дисковод (D:)
 - Панель управления
 - Сетевое окружение
 - Корзина

StaticMixerMesh.gtm
Файл "GTM"
292 КБ

sm.cfx
ANSYS CFX Pre- File
345 КБ

sm.def
ANSYS CFX Solver File
206 КБ

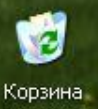



ANSYS CFX-11.0 Launcher (on COMP1)

File Edit CFX Show Tools User Help

CFX-Pre 11.0 CFX-Solver 11.0 CFX-Post 11.0

Working Directory C:/CFX

